

SOLICITATION FOR PROPOSAL (SFP)
SFP #1002048
Date of Issue: 1/25/2023

Due Date:	Responses due no later than 3:00 PM on 3/23/23. PROPOSALS WILL NOT BE ACCEPTED AFTER THIS TIME.
Tenant Agency:	Department of Human Services
County:	Sullivan (Refer to Appendix E for Geographic Boundaries)
Square Footage:	3,322 - 3,821
Term:	10 years with two - 5 year options
Type of Space:	<input checked="" type="checkbox"/> Office <input type="checkbox"/> Warehouse <input type="checkbox"/> Hangar <input type="checkbox"/> Institutional <input type="checkbox"/> Other
Parking Requirement:	The Commonwealth does not make parking a requirement of SFPs for the lease of real estate unless otherwise specified in the Agency Lease Specifications (Appendix D), however, proposers should provide information relative to the availability of private and/or public parking as well as the number of parking spaces and location of the parking if included in the proposal.
Additional Considerations:	Janitorial Services – Unless Lessor provides all janitorial services with its own employees, this requirement will be removed from the Lease and the Using Agency will be responsible for providing these services.

All questions and inquiries regarding this SFP must be directed to:

DGS Lease Contract Specialist: Steven Kraveski
Phone: 717- 287-2155
Email: skraveski@pa.gov

Submission Instructions:

The Department of General Services (DGS) will accept submission of proposals by email or by mail using the shipper of your choice. Please follow the below instructions. **PLEASE NOTE, DUE TO COVID-19, PROPOSERS ARE STRONGLY ENCOURAGED TO UTILIZE THE EMAIL OPTION TO ENSURE TIMELY RECEIPT BY DGS. WE ARE NOT CURRENTLY ACCEPTING PHYSICAL DROP OFF SUBMISSIONS.**

EMAIL:

Proposals must be submitted to RA-DGSLeasingSFPResponse@pa.gov. The subject line of the email must state the **SFP#, Agency, County, Leasing Coordinator's Name, and Due Date**. All required forms must be attached to the email and the proposer must request a "send/receive" receipt.

MAIL:

Proposals must be submitted in a sealed envelope to the Bureau of Real Estate, Room 503 North Office Building, Harrisburg, PA 17125 and received by the Commonwealth of Pennsylvania by the due date and time noted above. The envelope must be marked with the **SFP#, Agency, County, Leasing Coordinator's Name, and Due Date**. **This information must also be shown on the outside of any courier or mailing envelope.**

Table of Contents

Pages

General Information for the Proposer

3-5

Appendix A	Proposal Checklist and Acknowledgement
Appendix B	Small Diverse Business (SDB) and Small Business (SB) Participation Submittal/SDB and SB Letter of Intent
Appendix C	Sample Lease Cover Sheet and Standard Lease Terms & Conditions <i>(Sections 1 & 2 of New Lease)</i>
Appendix D	Standard Building Construction Specifications and Agency Space Requirements <i>(Sections 3 and 4 of New Lease)</i>
Appendix E	Geographic Boundaries

GENERAL INFORMATION FOR THE PROPOSER

Thank you for responding to the Commonwealth of Pennsylvania's Solicitation for Proposal to lease space to the Commonwealth. Please be advised that this is a proposal solicitation process. The Commonwealth reserves the right to reject any or all offers, waive any defect or negotiate for better terms. **Since this SFP includes several appendices, it is also advised that this document be read in its entirety so that the proposer is aware of all Commonwealth requirements and the necessary information that is to be submitted with your proposal. To be considered, all proposals must be submitted in accordance with these instructions.**

PLEASE NOTE THAT SFPs ARE NOT PUBLIC BID OPENINGS.

DGS Bureau of Real Estate (BRE), and only BRE, is authorized to negotiate the terms and conditions of a proposed lease agreement. No understanding shall be binding upon the Commonwealth until all of the following occur: (1) the parties' understanding has been reduced to a formal written lease agreement; (2) the lease agreement has received all necessary Commonwealth approvals, including, but not limited to, the approval of the Board of Commissioners of Public Grounds and Buildings; (3) the lease agreement has been signed by the Secretary of the Department of General Services, and (4) the fully executed lease agreement has been delivered by DGS to the selected proposer.

The Commonwealth strongly encourages the Lessor to meet with representatives from UniqueSource (the Pennsylvania marketing organization for agencies employing persons with disabilities) to explore subcontracting opportunities for supplies and services needed by the Lessor to perform the Lease. A list of all supplies and services that are currently provided by UniqueSource can be found at the following link: [UniqueSource Carve-Out List](#).

NOTICE TO PROPOSERS OF PREVAILING WAGE REQUIREMENTS

To the extent that a proposer offers to construct a new facility, to substantially rehabilitate an existing facility, or to substantially alter an existing facility in accordance with Commonwealth agency specifications/drawings, and the construction/substantial rehabilitation/substantial alterations will have a total estimated cost that exceeds \$25,000, the proposer must comply with the Pennsylvania Prevailing Wage Act, 43 P.S. § 165-1 *et seq.* as further detailed in Paragraph 32 of the Standard Terms and Conditions.

If, after receipt of proposals, the DGS determines that the lessor and lessor's contractor(s) should pay the prevailing minimum wage rates when the lessor's proposal did not include consideration of this requirement, DGS may give the proposer the opportunity to revise its offered rental amounts to include allowance for payment of prevailing wages.

NOTICE TO PROPOSERS OF ENHANCED MINIMUM WAGE PROVISIONS

Proposers must comply with the requirements of Executive Order 2016-02, issued March 7, 2016, which relates to the Enhanced Minimum Wage Provisions and is attached as Exhibit 5 of the Standard Terms & Conditions.

SUBMISSION OF PROPOSALS

To be considered, interested parties must comply with all of the requirements of this SFP. An interested party will make no other distribution of the proposal. An official who is authorized to bind the interested party to its provisions must sign the proposal. For this SFP, the conditions of the proposal must remain valid for at least ninety (90) days from the end date of this SFP or until a lease is fully executed. **Moreover, the contents of the selected proposal will become contractual obligations if a contract is entered into with the Commonwealth.**

A complete proposal package is necessary for evaluation of your proposal. Failure to include any of the required information or forms will delay evaluation of your proposal and may, at the Commonwealth's sole discretion, result in the rejection of your proposal.

Proposers may submit alternate proposals. In order to be considered as a complying submission, a proposal must initially adhere strictly to the solicitation specifications in all material regards. However, in addition to this component, a proposer may, at the proposer's discretion, submit one or more alternate proposals that vary from the specifications. In particular, the proposer may, by way of example, propose alternate finishes or spatial layouts that allow the proposer to submit a more competitive price proposal. The proposal must clearly label the primary proposal, and all alternates, and delineate a clear breakdown of the price differentials. DGS will consider and evaluate the primary and all alternate proposals at its sole discretion.

SELECTED PROPOSAL

The selected proposer will be expected to enter into a lease agreement with the Commonwealth's Lease Standard Terms & Conditions (STCs), which are attached as **APPENDIX C** of this SFP. Proposers are responsible for ensuring their understanding of the STCs.

SELECTION OR REJECTION OF PROPOSAL

The Commonwealth reserves the right to reject any and/or all proposals received as a result of this request, or to negotiate separately with competing proposers. If, in the opinion of the Commonwealth, contract negotiations with the selected proposer cannot be concluded within 30 days following the selected proposer's receipt of a draft lease agreement, the Commonwealth may, at its sole discretion, immediately discontinue negotiations with the selected proposer and commence negotiations with any other interested proposer. Proposers will be notified, in writing, of their non-selection.

INCURRING COSTS

The Commonwealth is not liable for any costs incurred by interested parties related to the preparation of their proposals for this SFP.

AMENDMENT TO THE SFP

If it becomes necessary to revise any part of this SFP, an amendment will be issued on eMarketplace (www.emarketplace.state.pa.us). **It will be the interested party's responsibility to check the website for amendments to the SFP prior to the submission of its proposal.**

DISCLOSURE OF PROPOSAL CONTENTS

- **Confidential Information.** The Commonwealth is not requesting, and does not require, confidential proprietary information or trade secrets to be included as part of proposers' submissions in order to evaluate proposals submitted in response to this SFP. Except as provided herein, proposers should not label proposal submissions as confidential proprietary, or trade secret protected. Any proposer who determines that it must divulge such information as part of its proposal must submit a signed written statement as described below and must additionally provide a redacted version of its proposal, which removes only the information the proposer considers to be confidential proprietary or trade secret, for required public disclosure purposes.
- **Commonwealth Use.** All material submitted with the proposal shall be considered the property of the Commonwealth of Pennsylvania and may be returned to the proposer only at the issuing office's option. The Commonwealth has the right to use any or all ideas not protected by intellectual property rights that are presented in any proposal regardless of whether the proposal becomes part of a lease. Notwithstanding any proposer copyright designations contained on proposals, the Commonwealth shall have the right to make copies and distribute proposals internally and to comply with public record or other disclosure requirements under the provisions of any Commonwealth or United States statute or regulation, or rule or order of any court of competent jurisdiction.
- **Public Disclosure.** After the award of a lease pursuant to this SFP, all proposal submissions are subject to disclosure in response to a request for public records made under the Pennsylvania Right-to-Know-Law, 65 P.S. § 67.101, et seq. If a proposal submission contains confidential proprietary information or trade secrets, a signed written statement to this effect must be provided with the submission in accordance with 65 P.S. § 67.707(b) for the information to be considered exempt from disclosure under 65 P.S. § 67.708(b)(11).

NEWS RELEASES

Any news releases pertaining to this project will be made in coordination with the issuing office, and subject to Commonwealth approval.

FACILITY ACCESS

Consistent with safety and operational factors, the selected proposer will provide the Commonwealth unlimited access to the leased premises during the construction period.

SMALL DIVERSE BUSINESS AND SMALL BUSINESS PARTICIPATION

The Commonwealth encourages participation by Small Diverse Businesses and Small Businesses as lessors, and also encourages all lessors to make significant commitments to use Small Diverse Businesses and Small Businesses as subcontractors. Additional information may be found in Appendix B of this SFP.

APPENDIX A

PROPOSAL CHECKLIST AND ACKNOWLEDGMENT

APPENDIX A

PROPOSAL CHECKLIST AND ACKNOWLEDGMENT

*The proposal submission must include this checklist signed by the proposer as well as all applicable documents listed below.

Instructions: Please provide a check mark for all items submitted in this Checklist. If a document is not provided, please provide an explanation in the space provided. Failure to follow these instructions will result in delayed evaluation of this SFP.

Check Mark	Document	Please explain if NOT included (<i>attach documentation if needed or appropriate</i>)
<i>The following forms are available electronically at the following link or by clicking on the form name below:</i> Leasing Forms		
	GSRE-19, Proposal to Lease Space to the Commonwealth	
	GSRE-6, Lessor Identity Disclosure	
	GSRE-47, Agency Agreement/Limited Agent Authority <i>*if applicable (required if an agent is involved in any way or if the payee remittance address differs from the Lessor address disclosed on the GSRE-6)</i>	
	GSRE-42M, Contractor Responsibility Certification	
	GSRE-61, Non-Disturbance and Attornment Agreement, (if applicable)	
<i>In addition to the forms listed above, please submit the following documents</i>		
	Appendix A, Proposal Checklist and Acknowledgment	
	Appendix B, Small Diverse Business (SDB) and Small Business (SB) Participation Submittal, SDB/SB Letter of Intent, if applicable.	
	Proposer acknowledges the proposal is based upon requirements to pay Prevailing Wages , if applicable, in accordance with Section III, Paragraph 32, of the Standard Terms & Conditions.	
	Proof of Site Control (<i>BRE recommends proposers obtain and maintain site control for the proposed property for a minimum period of 180 days from the end date of this SFP in order to allow sufficient time for site selection by the tenant agency, negotiations, processing and lease execution</i>).	
	An Area Map that identifies the building location, major arterials, and public transportation routes, etc.	
	Estimated Construction Schedule to include a timeline for producing a test fit, permitting approvals, construction, etc.	
	Disclose Flood Plain Status , if applicable. (50 yr., 100 yr., 500 yr., etc.)	
	Drawings – Site Plan(s), floor plans, elevations, building sections	
	Photographs – marked and labeled for easy reference	
	Additional supporting attachments/documents if needed and/or appropriate.	

An official, authorized to bind the proposer to its provisions, must sign the proposal and all required forms, including this Checklist.

Print Name

Signature

Date

APPENDIX B

SMALL DIVERSE BUSINESS (SDB) AND SMALL BUSINESS (SB) PARTICIPATION SUBMITTAL

SDB AND SB LETTER OF INTENT

APPENDIX B (part 1)

SMALL DIVERSE BUSINESS AND SMALL BUSINESS PARTICIPATION

This solicitation reflects material changes which have been made to the Commonwealth's lease solicitation process to encourage participation by small diverse businesses and small businesses in Commonwealth leasing.

The Commonwealth encourages participation in Commonwealth leases by Small Diverse Businesses and Small Businesses either directly as lessors, or through lessor contracts for services (such as design, construction, cleaning, repair, maintenance, snow removal or landscaping) or supplies related to the lease. Small Diverse Business and Small Business participation and commitments will be considered as a factor for selection for lease award.

A Small Business must meet each of the following requirements:

- The business must be a for-profit, United States business;
- The business must be independently owned;
- The business may not be dominant in its field of operation;
- The business may not employ more than 100 full-time or full-time equivalent employees;
- The business, by type, may not exceed \$38.5 million in gross annual revenues over the preceding three years.

For a proposer to receive credit for a commitment to a Small Business, the Small Business must complete the DGS/BDISBO self-certification process. Additional information on this process can be found at:
<https://www.dgs.pa.gov/Small%20Business%20Contracting%20Program/Pages/default.aspx>

A Small Diverse Business is a DGS-verified minority-owned small business, woman-owned small business, veteran-owned small business, service-disabled veteran-owned small business, LGBT-owned small business, disability-owned small business, or other small businesses as approved by DGS, that are owned and controlled by a majority of persons, not limited to members of minority groups, who have been deprived of the opportunity to develop and maintain a competitive position in the economy because of social disadvantages.

For a proposer to receive credit for a commitment to a Small Diverse Business, the Small Diverse Business must complete the DGS verification process. Additional information on this process can be found at:
<https://www.dgs.pa.gov/Small%20Diverse%20Business%20Program/Small-Diverse-Business-Verification/Pages/default.aspx>

The Department's directory of self-certified Small Businesses and DGS/BDISBO-verified Small Diverse Businesses can be accessed from: <http://www.dgs.internet.state.pa.us/suppliersearch>.

Questions regarding the Small Diverse Business and Small Business Programs, including questions about the self-certification and verification processes can be directed to:

Department of General Services
Bureau of Diversity, Inclusion and Small Business Opportunities (BDISBO)
Room 601, North Office Building
Harrisburg, PA 17125
Phone: (717) 783-3119
Fax: (717) 787-7052
Email: RA-BDISBOVerification@pa.gov
Website: www.dgs.pa.gov

NOTE: EQUAL EMPLOYMENT OPPORTUNITY AND CONTRACT COMPLIANCE STATEMENTS REFERRING TO COMPANY EQUAL EMPLOYMENT OPPORTUNITY POLICIES OR PAST CONTRACT/LEASE COMPLIANCE PRACTICES DO NOT CONSTITUTE PROOF OF SMALL DISADVANTAGED BUSINESS STATUS OR ENTITLE A PROPOSER TO RECEIVE CREDIT FOR SMALL DIVERSE BUSINESS UTILIZATION.

SMALL DIVERSE BUSINESS AND SMALL BUSINESS PARTICIPATION SUBMITTAL

Proposers that wish to receive consideration for making commitments to and/or that qualify as Small Diverse Business or Small Business are required to submit the Small Diverse Business and Small Business Participation Submittal Form (**Appendix B-part 1**) and related Letter(s) of Intent (**Appendix B-part 2**). The submittal must be provided on the Small Diverse Business and Small Business Participation Submittal form, with information as follows:

- A.** Proposers must indicate their status as a Small Diverse Business and as a Small Business through selection of the appropriate checkboxes.
- B.** Proposers must include a numerical percentage which represents the total percentage of the total proposed lease cost that the Proposer commits to paying to Small Diverse Businesses and Small Businesses as subcontractors.
- C.** Proposers must include a listing of and required information for each of the Small Diverse Businesses and/or Small Businesses with whom they will subcontract to achieve the participation percentages outlined on the Small Diverse Business and Small Business Participation Submittal.
- D.** Proposers must include a Letter of Intent (attached is a Letter of Intent template which may be used to satisfy these requirements) signed by both the Proposer and the Small Diverse Business or Small Business for each of the Small Diverse Businesses and Small Businesses identified in the Small Diverse Business and Small Business Participation Submittal form. At minimum, the Letter of Intent must include the following:
 - 1.** The fixed numerical percentage commitment and associated estimated dollar value of the commitment made to the Small Diverse Business or Small Business; and
 - 2.** A description of the services or supplies the Small Diverse Business or Small Business will provide; and
 - 3.** The timeframe during the initial lease term and any extensions, options and renewals when the Small Diverse Business or Small Business will perform or provide the services and/or supplies; and
 - 4.** The name and telephone number of the Proposer's point of contact for Small Diverse Business and Small Business participation; and
 - 5.** The name, address, and telephone number of the primary contact person for the Small Diverse Business or Small Business.
- E.** To receive consideration for Small Diverse Business or Small Business commitments (or consideration for the proposer's own status as a Small Diverse Business or Small Business), the Small Diverse Business or Small Business must be listed in the Department's directory of self-certified Small Businesses and verified Small Diverse Businesses as of the proposal due date and time.
- F.** Each Small Diverse Business and Small Business commitment which is credited by BDISBO along with the overall percentage of Small Diverse Business and Small Business commitments will become contractual obligations of the selected Proposer.

CONTRACT REQUIREMENTS – SMALL DIVERSE BUSINESS AND SMALL BUSINESS PARTICIPATION

All leases containing Small Diverse Business and Small Business Participation must contain the following lease provisions to be maintained through the initial lease term and any subsequent options or renewals, which will be included as an Exhibit to the Lease Standard Terms and Conditions:

- A.** The selected lessor's Small Diverse Business and Small Business commitment will become contractual obligations of the selected lessor upon execution of its lease with the Commonwealth.
- B.** Subcontracting commitments to Small Diverse Businesses and Small Businesses made at the time of proposal submittal or during lease negotiations must be maintained throughout the term of the lease. This requirement also applies to any subsequent lessor who takes the lease by assignment. Any proposed change must be submitted to BDISBO, which will, along with the Bureau of Real Estate, determine whether a proposed substitution or change in individual percentage commitments to Small Diverse Businesses or Small Businesses should be approved.
- C.** All Small Diverse Businesses and Small Businesses that contract with the lessor must perform at least 50% of the work subcontracted to them.
- D.** Subcontracting commitments to Small Diverse Business and Small Business must be maintained in the event the lease is assigned to another prime lessor.
- E.** The Selected lessor shall complete the Lessor's Quarterly Utilization Report and submit it to the Bureau of Real Estate and BDISBO within ten (10) business days at the end of each calendar quarter the lease is in force. This information will be used to track and confirm the actual dollar amount paid to Small Diverse Businesses and Small Businesses as lessors or contractors with lessors. Also, it is a record of fulfillment of the commitment the lessor made and for which it received consideration for selection. If there was no activity during the quarter, the form must be completed by stating "No activity in this quarter." A late fee of \$100.00 per day may be assessed against the Selected lessor if the Utilization Report is not submitted in accordance with the schedule above.
- F.** The Selected lessor shall notify the Bureau of Real Estate and BDISBO when circumstances arise that may negatively impact the Selected lessor's ability to comply with Small Diverse Business and/or Small Business commitments and to provide a corrective action plan. Disputes will be decided by the Bureau of Real Estate and BDISBO.
- G.** If the Selected lessor fails to satisfy its Small Diverse Business and/or Small Business commitment(s), it may be subject to a range of sanctions BDISBO, in consultation with the Bureau of Real Estate, deems appropriate. Such sanctions include, but are not limited to, one or more of the following: a determination that the Selected lessor is not responsible under the Contractor Responsibility Program; withholding of payments; suspension or termination of the lease consistent with the lease's default provisions, together with consequential damages; revocation of the Selected lessor's Small Diverse Business status and/or Small Business status; and/or suspension or debarment from future leasing opportunities with the Commonwealth.

**APPENDIX B (part 3)
SMALL DIVERSE AND SMALL BUSINESS
LETTER OF INTENT**

[DATE]

**[SDB/SB Contact Name
Title
SDB/SB Company Name
Address
City, State, Zip]**

Dear [SDB/SB Contact Name]:

This letter serves as confirmation of the intent of [Lessor] to utilize [Small Diverse Business (SDB) or Small Business (SB)] on SFP [SFP number and Title] issued by the [Commonwealth agency name].

If [Lessor] is the successful lessor, [SDB or SB] shall provide [identify the specific work, goods or services the SDB/SB will perform] during the initial term of the lease and during any extensions, options or renewal periods of the lease exercised by the Commonwealth, as more specifically set forth below: [identify the specific time periods during the initial contract term and any extensions, options and renewals when the component work, goods or services will be provided or performed.]

These services represent [identify fixed numerical percentage commitment] of the total proposed lease cost for the initial term of the lease. Dependent on final negotiated pricing, it is expected that [SDB or SB] will receive an estimated [identify associated estimated dollar value that the fixed percentage commitment represents] during the initial lease term.

[SDB/SB] represents that it meets the small or small diverse business requirements set forth in the RFP and all required documentation has been provided to [Lessor] for its SDB/SB submission.

We look forward to the opportunity to serve the [Commonwealth agency name] on this project. If you have any questions concerning our small business or small diverse business commitment, please feel free to contact me at the number below.

Sincerely,

Acknowledged,

Lessor Name
Title
Company
Phone number

SDB or SB Name
Title
Company
Phone number

APPENDIX C

COMMONWEALTH STANDARD LEASE

Lease Cover Sheet

Standard Lease Terms and Conditions

LEASE COVER SHEET



Lease Number: _____

FRE Contract Number: _____

Execution Date: _____

Commencement Date: _____

Expiration Date: _____

Lessor Name/Address:

Vendor #:

Lessee:

Commonwealth of Pennsylvania, acting through the Department of General Services, on behalf of the Choose an item.(Using Agency)

Address:

503 North Office Building
Harrisburg, PA 17125

Lessor Contact:

Phone: / Mobile:

Fax:

Email:

DGS Bureau of Real Estate

Phone: 717-787-4394

Fax: 717-783-0570

Premises Address

Street:

City: State: Zip Code:

County: Choose an item.

Usable Area (Sq.Ft.):

Parking Location: No. of Spaces:

Base Rent [per net usable square foot]: \$

Additional Rent [per net usable square foot]: \$

Total Rent [per net usable square foot]: \$

Monthly Rent for First Year: \$

Annual Rent for First Year: \$

Initial Term: years

No. of Renewal Options: Length of Option Terms: Notification Period to Exercise Options: days

Option Years Base Rental Rates [per net useable square foot]:

Option One: \$ Option Two: \$

Termination Notification Period: days

Property Management:

Contact Name:

Phone: / Mobile:

Email:

Utilities Provided by Lessor:

- Electric/Gas/Oil/Steam
- Hot/Cold Water
- Sewer
- HVAC

Services Provided by Lessor:

- Janitorial
- Snow Removal
- Pest Control
- Grounds Maintenance (lawn, shrub care)
- Building Maintenance

CONSTRUCTION/RENOVATIONS

Construction Period (if applicable): days (from Lease Execution Date)

This Lease is comprised of the following documents: Lease Cover Sheet; Lease Terms and Conditions (Section 1); Service and Maintenance (Section 2); Standard Building Construction Requirements (Section 3); Agency Space Requirements (Section 4); and all Exhibits

Amortized Construction Costs (if any): \$ _____ *(applies to Paragraphs 1.6 and 1.7 of the Lease)*

Lessor and Lessee have agreed to the following Lease changes prior to execution:

-
- All other provisions of these Terms & Conditions which are not specifically modified as above remain in full force and effect.

This Lease is comprised of the following documents: Lease Cover Sheet; Lease Terms and Conditions (Section 1); Service and Maintenance (Section 2); Standard Building Construction Requirements (Section 3); Agency Space Requirements (Section 4); and all Exhibits

LESSOR:

Signature: _____

Printed Name: _____

Title: _____

LESSEE:

**Commonwealth of Pennsylvania
Acting Through The
Department of General Services**

Signature: _____

Printed Name: _____

Title: _____ **Secretary of General Services** _____

BOARD OF COMMISSIONERS OF PUBLIC GROUNDS AND BUILDINGS:

Commonwealth Treasurer

Governor

APPROVED AS TO FORM AND LEGALITY:

Office of General Counsel

By _____

Office of Attorney General

By _____

This Lease is comprised of the following documents: Lease Cover Sheet; Lease Terms and Conditions (Section 1); Service and Maintenance (Section 2); Standard Building Construction Requirements (Section 3); Agency Space Requirements (Section 4); and all Exhibits

TABLE OF CONTENTS

Definitions	1
Background.....	3
1 Terms and Conditions.....	3
1.1 Incorporation of Definitions and Background Clauses.....	3
1.2 Premises.....	3
1.3 Renewal Options	3
1.4 Holdover/Termination	3
1.5 Non-Appropriation/Cancellation	4
1.6 Termination for Convenience	4
1.7 Lessor’s Duty to Mitigate Damages	4
1.8 Rent.....	4
1.9 Taxes	5
1.10 Lessee’s Alteration Rights/Leasehold Improvements (LHI)	5
1.11 Utilities and Services	5
1.12 Maintenance and Repairs	5
1.13 Certificate of Occupancy	5
1.14 Insurance.....	5
1.15 Hold Harmless.....	7
1.16 Liquidated Damages.....	7
1.17 Damage/Destruction.....	7
1.18 Encumbrances.....	7
1.19 Regulatory Requirements	7
1.20 Vending	7
1.21 Asbestos.....	8
1.22 Assignment by Lessor.....	8
1.23 Assignment and Subletting by Lessee	8
1.24 Right to Know Law Requirements.....	8
1.25 Payments of Prevailing Minimum Wages	9
1.26 Accessibility to the Premises by Individuals with Disabilities	10
1.27 Contractor Integrity Provisions	11
1.28 Contractor Responsibility Provisions	13
1.29 Offset Provisions	13
1.30 Nondiscrimination/Sexual Harassment Clause	13
1.31 Enhanced Minimum Wage Provisions	14
1.32 Notice.....	15

1.33	Events of Default.....	15
1.34	Remedies of Lessee.....	15
1.35	No Waiver of Rights	16
1.36	Disputes	16
1.37	Modifications to the Lease.....	17
1.38	Choice of Law	17
1.39	Review of Lease.....	17
1.40	Execution.....	17
1.41	Time is of the Essence.....	17
1.42	Binding Successors and Assigns	17
1.43	Survival.....	17
1.44	Conflicts Within the Lease	17
1.45	Integration	17
1.46	Force Majeure.....	17
1.47	Surrender of Premise	18
1.48	Exhibits Part of Lease	18
2	Services and Maintenance	23
2.1	Provision of Services, Access, and Normal Hours of Operation.....	23
2.2	On-Site Lessor Management.....	23
2.3	Identity Verification of Personnel	23
2.4	Services	23
2.5	Maintenance	25
3	Standard Building Construction Specifications	29
3.1	General Requirements	29
3.2	General Design and Construction Requirements.....	30
3.3	Construction Specifications.....	32
4	Agency Space Requirements	44
4.1	General Requirements	44

DEFINITIONS

Additional Rent

The first year's Additional Rent is as set forth on the Lease Cover Sheet. The Additional Rent shall be annually adjusted, up to a maximum of 5 percent (5%) of the preceding year's Additional Rent, to cover increases or decreases in the costs of real estate taxes, utilities, trash removal, insurance, and janitorial services. The actual amount of the annual adjustment (increase or decrease) shall be determined by applying the Consumer Price Index for All Urban Consumers (CPI-U), Northeast Cities Index to the amount of the Additional Rent for the preceding year of the Lease. The Additional Rent shall not be adjusted to reflect actual costs incurred by Lessor during the term of this Lease, nor shall the amounts paid as Additional Rent be adjusted to reflect changes in the above Lessor costs.

Amenity Areas

A portion of a property/building address that adds a convenience for the occupants of a floor or building and that is not used exclusively by any one occupant. Refer to the most current version of the American National Standards Institute/Building Owners and Managers Association (ANSI/BOMA) standards at the time of lease execution. Amenity Areas are not included in the Rent.

Base Rent

Negotiated rent, not including Additional Rent, due to the Lessor. The Base Rent shall include pricing for Tenant Improvements (TIs) for the initial build-out of the Premises, which is to be completed prior to Lease Commencement unless lump sum payment is otherwise specified.

Commencement Date

The mutually agreed upon date established by Lessor and Lessee at the time the Premises is accepted for occupancy by the Lessee, as memorialized by the Using Agency's completion and execution of an "Acceptance of Leased Premises and/or Renovations Inspection Report" (GSRE-42-N), a sample of which is attached hereto as Exhibit 1. The Commencement Date is the date rental payments commence; therefore, it is recommended that this date be either the 1st or the 15th of any given month. The Commencement Date is also considered the Lease anniversary date for the purpose of calculating the annual CPI adjustment.

Consumer Price Index (CPI)

An economic indicator used to increase or decrease the Additional Rent. Refer to the CPI Detailed Report published by the U. S. Department of Labor, Bureau of Labor Statistics. The CPI-U, NE Cities Index reported four (4) months prior to each anniversary of the Commencement Date shall be used to determine the amount of the adjustment to the Additional Rent.

DGS/BRE

Commonwealth of Pennsylvania, Department of General Services, Bureau of Real Estate.

Execution Date

The Execution Date shall be the date the Lease is signed by the Secretary of the Department of General Services after all other approvals have been obtained. This date shall be entered on the appropriate line of the first page of the Lease Cover Sheet.

Expiration Date

The Expiration Date shall be the end of the term specified in relationship to the Commencement Date, and thus entered on the Lease Cover Sheet and automatically updated per subsequent renewals and/or amendments.

Initial Term

The Initial Term shall be the number of years the Lease is in effect as identified on the Lease Cover Sheet that begins on the Commencement Date.

Lease

The binding contract granting use and occupancy of the Premises in exchange for Rent between the Lessor and Lessee, which is collectively comprised of the following: Lease Cover Sheet; Lease Terms and Conditions (Section 1); Service and Maintenance (Section 2); Standard Building Construction Requirements (Section 3); Agency Space Requirements (Section 4); and all Exhibits.

Lease Amendment

A written agreement between the Lessor and the Lessee modifying the terms and/or conditions of the Lease.

Lease Cover Sheet

The cover page of the Lease, which shall include, but not be limited to, the name, address and contact information of the Lessor, name, address and contact information of the Lessee, leased Premises address, Rental Rate, Useable Area, initial lease term, renewal option terms, and any clarifying language or modification to the Lease above and beyond the standard language contained in the Lease.

Leasehold Improvements (LHI)

Additions, alterations, or improvements to the Premises, undertaken at the request of the Lessee, which occur after the Execution Date of the Lease. This includes improvements requested by Lessee, but which are not part of the original Tenant Improvements.

Leasehold Improvement Change Order

A document signed by the Lessor, and approved by DGS/BRE, that documents the Lessor's approval of the Leasehold Improvement(s) and agreement to construct and renovate the Premises, as requested by the Lessee, and that the Lessor agrees to furnish all labor and materials to complete the improvements in exchange for payment by Lessee. A sample of this document is attached hereto as an Exhibit.

Leasehold Improvement Consent Form (STD-539)

A document signed by the Lessor and approved by DGS/BRE that documents the Lessor's approval of the Leasehold Improvement and provides authorization for the Lessee and/or Lessee's contractor to complete the requested improvement(s) at Lessee's sole cost and expense. A sample of this document is attached hereto as an Exhibit.

Lease Year

Each successive twelve (12) month period beginning on the Commencement Date.

Lessee

The Commonwealth of Pennsylvania, acting through the Department of General Services, on behalf of the Using Agency as assigned by DGS/BRE.

Lessor

The party that has the legal right and ability to lease the Premises to the Lessee.

Pre-Construction Meeting

Meeting held between the Lessee and Lessor, to include but not be limited to both parties' agents, employees, licensees or invitees, after a lease or amendment is fully executed, but prior to any work commencing on the Premises, to review and discuss final plans, timelines, and concerns of all parties involved.

Preliminary Design Site Visit

Meeting held between the Lessee and Lessor, to include but not be limited to both parties' agents, employees, licensees or invitees, after a lease or amendment is fully executed, but prior to the completion of a preliminary design, to coordinate the build-out and the Using Agency's specific requirements with the existing conditions.

Premises

The property or part of the property located at the Premises address identified on the Lease Cover Sheet, more specifically described on the plan and/or specifications attached to the Lease and consisting of the amount of Usable Area identified on the Lease Cover Sheet, together with Amenity Areas. Lessor and Lessee agree that the plan and/or specifications are subject to adjustment as agreed upon by the Lessor and Lessee, and in the event that there are adjustments to the plan and/or specifications, the Lessor and Lessee agree to replace any documents related hereto with a revised version of such documents, signed and dated by Lessor and Lessee, in order to accurately depict the Premises.

Rent

The payment made to the Lessor by the Lessee for use of the Premises as set forth on the Lease Cover Sheet and adjusted as provided herein. Rent shall be paid in equal monthly installments.

Rental Rate

The sum of the Base Rent and the Additional Rent as set forth on the Lease Cover Sheet.

Tenant Improvements (TIs)

Additions, alterations or improvements to the Premises and/or Amenity Areas, undertaken by the Lessor prior to Commencement of the Lease, and in accordance with Sections 3 and 4 of the Lease. The cost of TIs is typically amortized into the Base Rent. TIs over and above those stated in the Lease must be memorialized and paid for via a Lease Amendment or Settlement Agreement.

Termination Date

The date the Lease is terminated with prior notification from either party to the other. The required notification period is identified on the Lease Cover Sheet.

Usable Area

The total space being occupied and paid for solely by the Lessee. Refer to the most current version of the ANSI/BOMA Office Area (ABOA) standard(s) for measuring buildings at the time of lease execution.

Using Agency

The Commonwealth of Pennsylvania department, agency, office, board, or commission assigned by DGS/BRE, at its sole discretion, to occupy the Premises.

BACKGROUND

By the Act of April 9, 1929, P.L. 177, as amended, 71 P.S. Section 632(d), the Department of General Services is, with the approval of the Board of Commissioners of Public Grounds and Buildings, authorized and empowered to rent proper and adequate offices, rooms, or accommodations for any department, board, or commission that cannot be properly and adequately accommodated with offices, rooms, and accommodations in the Capitol buildings.

Lessee desires to lease the Premises from Lessor for use by the Using Agency upon the terms and conditions set forth in the Lease.

In consideration of the following mutual promises and intending to be legally bound hereby, Lessor and Lessee agree to the following terms and conditions.

1 TERMS AND CONDITIONS

1.1 Incorporation of Definitions and Background Clauses

Any and all Background clauses, Definitions, and Exhibits are incorporated into the Lease by reference.

1.2 Premises

- 1.2.1 Lessor leases the Premises to Lessee for use and occupancy by the Using Agency and Lessee leases the Premises from Lessor for use and occupancy by the Using Agency.
- 1.2.2 The building shell, which includes the base structure and building enclosure components, shall be designed, constructed, and maintained in accordance with the standards set forth herein and completed prior to acceptance of the Premises.
- 1.2.3 Base structure and building enclosure components shall be complete. All Amenity Areas accessible by the Lessee such as lobbies, fire egress corridors and stairwells, elevators, garages, and service areas, shall be complete. Restrooms shall be complete and operational. All newly installed building shell components, including but not limited to, heating, ventilation, and air conditioning (HVAC); electrical, ceilings; sprinklers; etc., shall be furnished, installed, and coordinated with TIs. Circulation corridors are provided as part of the base building only on multi-tenanted floors where the corridor is common to more than one tenant. On single-tenant floors, only the fire egress corridor(s) necessary to meet code is provided as part of the shell.
- 1.2.4 The Usable Area shall be subject to verification in accordance with the ABOA standards. Lessee shall have the right to use any space within the Premises in excess of the Usable Area without the requirement to pay any additional rent, costs, or charges. In the event the actual square footage is less than the Usable Area, then Lessee shall have the right to the following:
 - a. Reduce the amount of Usable Area and pay for the reduced amount of the Usable Area, which must be memorialized by a fully executed Amendment; or
 - b. Terminate the Lease without liability for any costs or future rent, if Lessee determines, in its sole judgment, that the actual amount of Usable Area provided is insufficient to meet Lessee's needs.
- 1.2.5 Lessor shall lease the number of parking spaces to Lessee as set forth on the Lease Cover Sheet. Lessor agrees that these parking spaces are included in the Rental Rate for the Premises as set forth on the Lease Cover Sheet.

1.3 Renewal Options

Lessee, at its sole discretion, shall have the option to renew this Lease for additional term(s) as set forth on the Lease Cover Sheet. In order to exercise an option, Lessee must give Lessor prior written notice, as set forth on the Lease Cover Sheet, before the expiration of the then current term. The Rental Rate for each option term shall be calculated by adding the then current Additional Rent to the Base Rent for the option term.

1.4 Holdover/Termination

Should Lessee holdover in possession after the expiration of the Initial Term of this Lease (without exercising any option to renew), or after the expiration of any renewal term (without exercising any remaining option to renew), such holding over shall not be deemed to extend the term of this Lease, but the tenancy thereafter shall continue from month to month, subject to the covenants and conditions of this Lease, until either party shall give the other prior written notice, as set forth on the Lease Cover Sheet, of its intention to terminate the tenancy.

1.5 Non-Appropriation/Cancellation

It is understood and agreed upon between the parties hereto that if the governmental function for which the Premises are being leased is abolished, limited, or restricted by any Act of Legislature, including a failure of sufficient appropriation by the General Assembly to continue payment of Rent or any other amount hereunder, or by Law of Congress, or by any legal action taken under authority conferred by such acts or laws or decision(s) of court, then the Lessee shall have the right to cancel this Lease by giving one (1) month prior written notice. If the Lease is canceled pursuant to the provisions of this paragraph, and if the Using Agency's annual appropriations permit, Lessee shall reimburse Lessor for any unamortized costs of renovations performed by Lessor pursuant to this Lease, at the Lessee's request, and which are peculiar to Lessee's tenancy. The total amount of amortized costs is set forth on the Lease Cover Sheet or subsequent Lease Amendments, when applicable.

1.6 Termination for Convenience

In addition to any rights of termination already contained in the Lease, Lessee is hereby granted the right to terminate this Lease in accordance with this paragraph whenever the Lessee shall determine, in its sole discretion that such termination is in the best interest of the Lessee. In order to terminate the Lease under this paragraph, Lessee must provide at least six (6) months prior written notice to Lessor of the intended date of termination. Such termination date may not be prior to the expiration of at least 50 percent (50%) of the Initial Term of this Lease. In the event Lessee exercises this option to terminate for its convenience, Lessee shall pay Lessor a sum equivalent to three (3) months Base Rent as an early termination fee (the "Early Termination Fee"). In addition to the Early Termination Fee, if the parties have agreed on the total costs of renovations prior to the execution of the Lease and the Lease is cancelled by Lessee pursuant to the provisions of this paragraph, Lessee shall reimburse Lessor for any unamortized costs of renovations performed by Lessor pursuant to this Lease at Lessee's request and which are peculiar to Lessee's tenancy. The total amount of amortized costs is set forth on the Lease Cover Sheet and/or subsequent Lease Amendments, when applicable.

Upon payment of the Early Termination Fee, Lessor releases Lessee from any claims whatsoever, at such time or in the future, whether known or unknown, for any damages, consequences, or liabilities associated with Lessee's exercise of this paragraph.

1.7 Lessor's Duty to Mitigate Damages

In the event Lessee abandons the Premises prior to the end of the then current lease term, Lessor shall have an affirmative duty to proceed in good faith, and with due diligence, to make reasonable efforts to mitigate its damages and prevent further loss.

1.8 Rent

- 1.8.1 Lessee shall pay Lessor Rent for the use and occupancy of the Premises. The Rental Rate for all succeeding Lease Years, including any option terms, shall be annually adjusted by the Lessee in accordance with the CPI adjustment, which adjustment (decrease or increase) is applied to the Additional Rent for the then current Lease Year.
- 1.8.2 Lessee reserves the right, upon thirty (30) days prior written notice to Lessor, to offset future Rent payments to recover any prior Rent overpayment made by Lessee to Lessor.
- 1.8.3 Lessee shall make Rent payments electronically through Automated Clearing House (ACH). Lessor shall complete the Pennsylvania Electronic Payment Program (PEPP) Enrollment Form, which is available at: <https://www.vendorregistration.state.pa.us/cvmu/paper/Forms/ACH-EFTenrollmentform.pdf>.
 - a. It shall be the responsibility of the Lessor to ensure that the ACH information submitted is correct and to ensure the most current information is provided to the Vendor Data Management Unit throughout the term of the Lease.
 - b. Lessor hereby acknowledges and agrees that failure to timely submit and maintain accurate and complete ACH information may result in delays in Rent, which shall not be deemed an Event of Default by Lessee.
- 1.8.4 Budget Impasse (Availability of Funds): Lessee's timely payment of rent is contingent upon the annual appropriation of funds made available to the Lessee through the passage of a budget by the Commonwealth. Lessee's inability to pay rent on a timely basis during the period of a budget impasse is not an event of default. In the event of an extended budget impasse in excess of three (3) months, if funding is available, and at the discretion of the Department of General Services, the Commonwealth may make utility payments directly to the utility companies and any amount paid directly to utility companies will be deducted from rental payments upon the passage of a budget. Should a budget impasse occur, upon passage of a budget, the Lessee will process for payment all rental payments due and owing to the Lessor without penalty or interest.

1.9 Taxes

Lessor shall pay, in a timely manner, all real estate taxes; municipal, general, and special assessments; and other taxes of any nature applicable to the Premises, Amenity Areas, and parking spaces subject to this Lease, directly to the taxing authority.

1.10 Lessee's Alteration Rights/Leasehold Improvements (LHI)

For the life of the Lease, Lessee must be offered the option to upgrade existing space for operational use, or to make additional alterations and renovations to the Premises Any and all Leasehold Improvements requested by Lessee, and agreed upon by Lessor, for the life of the Lease, shall be approved by both Lessor and Lessee through the full execution of either a Lease Amendment, LHI Consent Form, or LHI Change Order, whichever is applicable as determined by DGS/BRE, prior to the commencement of any LHI. Lessor shall not unreasonably withhold approval.

1.11 Utilities and Services

Lessor shall, at its sole cost and in return for Rent paid by Lessee pursuant to this Lease, provide, maintain and pay the costs and periodic charges for the utilities and services set forth on the Lease Cover Sheet in accordance with Section 2 of this Lease.

1.12 Maintenance and Repairs

Lessor shall, at its sole cost and in return for Rent paid by Lessee, maintain, repair, replace and provide the continuous upkeep of the exterior of the building and all internal building systems, including but not limited to electrical, lighting, plumbing, heating, ventilation equipment, air conditioning, elevators, escalators, and/or lifts in accordance with Section 2 of this Lease.

1.13 Certificate of Occupancy

- 1.13.1 Lessor shall furnish and visibly display a copy of a Certificate of Occupancy, issued by any and all federal, state, and local government entities, at the time of occupancy by Lessee, of the Premises.
- 1.13.2 If Lessee, after notifying Lessor prior to the action, increases or decreases staff, Lessor shall be responsible to make sure the Premises remains in compliance with all Regulatory Requirements in relation to occupancy.

1.14 Insurance

- 1.14.1 At all times during the term of the Lease, Lessor shall procure and maintain, at its expense, the following types of insurance, issued by companies acceptable to Lessee and authorized to conduct such business under the laws of the Commonwealth:
 - a. Worker's Compensation Insurance for all of Lessor's employees and those of any contractor engaged in work at the Premises, in accordance with the Worker's Compensation Act of 1915 and any supplements or amendments thereto.
 - c. General Liability Insurance to protect Lessee, Lessor, and any and all contractors from claims for damages for personal injury (including bodily injury), sickness or disease, accidental death and damage to property, including loss of use resulting from property damage, which may arise from services performed by Lessor, its agents or employees under this Lease, or from an alleged defective, dangerous, or untenantable condition of the Premises. The limits of such insurance shall be in an amount not less than five hundred thousand dollars (\$500,000) per each person and two million dollars (\$2,000,000) per each occurrence. Such policy shall name the Commonwealth of Pennsylvania as an additional insured.
 - d. Builders Risk: During the period of any construction of the Premises or the building (including, without limitation, the work), Lessor shall purchase and maintain (or shall cause its general contractor to purchase and maintain) a Builders Risk Coverage or equivalent policy form in the amount of the initial construction contract sum plus the value of subsequent contract modifications and the cost of materials supplied or installed by others, comprising the total value of the entire Building on a replacement cost basis without optional deductibles. Such property insurance shall also cover portions of the work stored off the site and portions of the work in transit. Such insurance shall, unless otherwise agreed in writing by all persons and entities that are beneficiaries of such insurance, (a) be maintained until the construction project is complete, (b) include at least the interests of Lessor, Lessee, and any and all contractors, and (c) include Loss of Use insurance due to a covered loss, including Leasehold Interest Coverage in favor of Lessee subject to a minimum limit of twice the Rent due for the first Lease Year. The period of coverage for this Loss of Use shall be, at a minimum, the length of the original construction period of the applicable construction project.

- e. Property: At all other periods during the term of the Lease, Lessor shall provide Commercial General Liability or equivalent property insurance covering the Premises and appurtenant structures and improvements up to the full replacement cost thereof, including all fixtures, equipment, machinery, and apparatus that constitute a permanent part of such Building, and other structures and improvements. If the coverage is available and commercially appropriate (with commercially appropriate sublimits), such property insurance shall insure against all risks of direct physical loss or damage including without limitation the perils of fire (with extended coverage), and physical loss or damage including theft, vandalism, malicious mischief, collapse, earthquake, flood, windstorm, and boiler/machinery. Such policy shall also include coverage for debris removal and the enforcement of any legal requirements requiring the upgrading, demolition, reconstruction, or replacement of any portion of the Premises as the result of a covered loss. Such policy shall permit partial occupancy as construction progresses.

1.14.2 At all times when Lessor is obligated to maintain insurance coverage as provided in this paragraph. Lessor shall comply with the following requirements:

- a. All policies will be issued by carriers having ratings of Best's Insurance Guide A- or better, or its substantial equivalent if such Guide is no longer published and admitted or permitted to engage in the business of insurance in the Commonwealth for the past five (5) years. If any coverage is provided by an unrated captive, such captive will have financial resources of equivalent standing to those meriting a rating of Best's Insurance Guide A- or better, with audited financials of the captive to be furnished annually to Lessee.
- b. Any non-standard policy or endorsement other than as specified herein must be approved in advance in writing by Lessee, which approval shall not be unreasonably withheld, conditioned, or delayed. No policy will contain a deductible or self-insured retention in excess of the limits set forth above, unless mutually agreed by Lessor and Lessee in their sole discretion.
- c. If the forms of policies, endorsements, certificates, or evidence of insurance required hereunder are superseded or discontinued, Lessee will have the right to require Lessor to provide other substantially equivalent forms consistent with the standards observed by prudent and reputable owners of office buildings of the same class as the Premises, in the locality of the Premises. Evidence of the insurance coverage required to be maintained by Lessor hereunder, represented by certificates of insurance issued by the insurance carrier(s) and constituting actual evidence of coverage, must be furnished to Lessee, at the address set forth in this Lease at least thirty (30) days prior to the Commencement Date, and at least thirty (30) days prior to the expiration of current policies. Such certificates will specify the additional insured or certificate holder status of the Commonwealth of Pennsylvania. Such certificates will state that persons and parties required to be named hereunder as additional insureds have been so named, and that such additional insureds will be notified in writing thirty (30) days prior to cancellation, material change, or non-renewal of insurance. The "endeavor to" language contained in any cancellation notice section of such certificate shall be deleted. Such certificates, or a separate writing issued by the insurer or its agent together with such certificate, shall set forth the amounts of deductibles and all self-insured retentions.
- d. If Lessor fails to comply with its covenants made in this paragraph, Lessee may, at its option, cause insurance as aforesaid to be issued, and in such event, Lessor agrees to pay the premium for such insurance promptly upon Lessee's demand.
- e. Lessor may carry any insurance required by this paragraph under a blanket policy, applicable to the property to be insured hereunder for the risks and in the amounts required pursuant to this Paragraph, provided that all requirements of this paragraph shall be complied with in respect of such policy.
- f. If requested in writing, Lessor shall provide to Lessee a certified copy of any and all insurance policies or endorsements required by this Lease, and Lessor shall provide such certified policies to Lessee within thirty (30) days after written request is made. These certificates shall contain a provision that the coverage afforded under the policies will not be canceled or changed until at least thirty (30) days prior written notice has been given to Lessee.
- g. All liability insurance to be maintained by Lessor shall be on an occurrence basis.

1.14.3 At least thirty (30) days prior to the Commencement Date, Lessor shall provide Lessee with evidence, reasonably satisfactory to Lessee, that Lessor requires any other tenants of the Premises to carry commercial reasonable limits of liability insurance to respond to liability exposures associated with such other tenants' occupancy of the Premises.

1.15 Hold Harmless

Lessor shall save and hold harmless Lessee, and its officers, agents, and employees, from any and all claims, demands, actions, damages, losses liability, and expense (including, but not limited to, consequential damages and reasonable attorney's fees) of any nature based upon or arising out of any of the following:

- a. Any service performed by Lessor, its agents, or employees under this Lease, except such services as are properly performed at the express direction of Lessee;
- b. Any actual or alleged defective, dangerous or untenantable condition of the Premises;
- c. Violations of, or noncompliance of the Premises, any statute, ordinance, rule or regulation of any governmental authority, or violations of, or noncompliance with, any statute, ordinance, rule, or regulation of any governmental authority on the part of Lessor, its employees, agents, or contractors;
- d. Any breach of any of the covenants, representations, or warranties of Lessor contained in this Lease;
- e. Any personal injury, death, or damage to property caused by Lessor, its employees, agents, or contractors.

1.16 Liquidated Damages

Unless Lessee has agreed, in writing, to an extension of the completion date for the construction or substantial rehabilitation of the Premises, if Lessor fails or refuses to comply with the provisions in this Lease, Lessee, after giving Lessor thirty (30) days' notice, in writing, shall have the right to terminate this Lease and/or exercise any other remedy it may have under the Lease or at law. In addition to these rights, Lessor must pay Lessee, at Lessee's option, as liquidated damages, one percent (1%) of the first year's annual Rent under this Lease for each and every day the Premises are not ready for occupancy by the date provided herein.

1.17 Damage/Destruction

In the event of damage to the Premises by fire, flood, lightning, or other Act of God, or act of terrorism rendering it impossible or substantially inconvenient for Lessee to continue to occupy or use the Premises for its operations, the Lessor, after notice from the Lessee of the condition shall have sixty (60) days to repair and/or restore the Premises to a tenantable condition. If Lessor fails to repair and/or restore the Premises within said period of sixty (60) days, or if Lessor fails to make reasonable progress during the sixty- (60) day period, as determined by Lessee in its sole discretion, Lessee may, at its option: (a) terminate this Lease by giving Lessor thirty (30) days written notice or (b) after first giving Lessor fifteen (15) days written notice, repair and restore the Premises to a tenantable condition, and deduct such costs made in restoration of the Premises from the Rent due the Lessor. At Lessee's option, payment of Rent shall abate as long as the Premises remains in an untenantable condition after notice to Lessor and shall resume only after the condition has been substantially corrected. Such abatement shall be prorated on the portion of the Premises that is or remains untenantable.

1.18 Encumbrances

Lessor covenants that it has good and clear title to the Premises, or that it has the right and authority from the owner of the Premises, to lease the Premises to Lessee; that Lessee shall enjoy peaceful and uninterrupted possession of the Premises during the term of this Lease; and that Lessor shall execute and provide to Lessee and any mortgagee that may hold an encumbrance against the Premises, a reasonable Subordination, Non-Disturbance, and Attornment Agreement with respect to matters related to this Lease and/or the status of performance of obligations by the parties under this Lease.

1.19 Regulatory Requirements

With full understanding by Lessor of the intended use of the Premises by Lessee, Lessor shall ensure that the Premises conform to all applicable laws, codes, ordinances, rules, and regulations (collectively, "Regulatory Requirements"). Lessor, at its sole expense, shall promptly take action to comply with changes in any regulatory requirements when such changes occur during the term of this Lease and any renewal thereof.

1.20 Vending

Lessee reserves the right to install and operate vending machines on the Premises without any additional payment to Lessor or any sharing of the income derived from the operation of the vending machines. Lessor shall not install or operate any vending machines in the Premises unless agreed upon by the Lessee. If the Premises are located in a multi-tenant building, Lessor may install vending machines in the Amenity Areas of the building. All receipts from the operation of vending machines, except for those machines installed by Lessor in Amenity Areas, after costs of goods sold, and all commissions paid by a commercial vending concern, shall accrue to the licensed blind vendor operating the vending machines on the Premises or, if none, to the Lessee Employment Fund for the Blind, as required by the Little Randolph-Sheppard Act, 71 PS §§ 580.1-20.

1.21 Asbestos

- 1.21.1 Lessor represents and warrants that the Premises and/or Lessor's building and building systems or components serving the Premises will, no later than the Commencement Date, be free of any and all asbestos and asbestos-containing materials not properly encapsulated or enclosed in compliance with all Regulatory Requirements, at Lessor's sole expense. Any asbestos or asbestos-containing materials not properly encapsulated or enclosed discovered in or on the Premises at any time during the lease term shall be professionally removed or remediated by the Lessor, in compliance with all Regulatory Requirements, at Lessor's sole expense.
- 1.21.2 Lessor agrees to protect, indemnify, and hold harmless Lessee from and against any and all liabilities, losses, damages, costs, expenses (including, without limitation, reasonable attorney's fees and costs), cause of action, suits, claims, demands, or judgments of any nature arising from any injuries to, or the death of any person growing out of, or connected with, the presence of asbestos in the Premises, the building or any of the building systems or components serving the Premises.

1.22 Assignment by Lessor

- 1.22.1 Lessee shall not be obligated to recognize any assignment or other transfer of the Lease by Lessor, nor shall Lessee be obligated to pay Rent or other sums payable to Lessor hereunder, to any assignee or other transferee of the interest of Lessor in the Lease, unless and until such assignment or transfer has been approved, by Lessee, subject to approval by the Board of Commissioners of Public Grounds and Buildings, and execution by the Secretary of the Department of General Services; and which approval shall not be unreasonably withheld.
- 1.22.2 Lessor shall provide a written request for approval of assignment or other transfer of the Lease by Lessor to Lessee at least ninety (90) days prior to transfer.
- 1.22.3 Lessor must cooperate with Lessee in providing, within a timely manner, all required applications, documents, and other information required to enable Lessee to assess and act upon Lessor's request for approval.

1.23 Assignment and Subletting by Lessee

Lessee shall have the right to assign the Lease or sublet all or any part of the Premises subject to the approval of Lessor, which approval shall not be unreasonably withheld, delayed, or conditioned. Use of the Premises by another Commonwealth agency shall not be deemed a sublease or assignment and shall not require the consent or approval of Lessor. Lessee will not be released from liability as a result of any assignment or sublease.

1.24 Right to Know Law Requirements

The Pennsylvania Right-to-Know Law, 65 P.S. §§ 67.101-3104 ("RTKL") applies to this Lease.

- 1.24.1 If Lessee needs Lessor's assistance in any matter arising out of the RTKL related to this Lease, it shall notify Lessor using the legal contact information provided in this Lease. Lessor, at any time, may designate a different contact for such purpose upon reasonable prior written notice to Lessee.
- 1.24.2 Upon written notification from Lessee that it requires Lessor's assistance in responding to a request under the RTKL for information in Lessor's possession, constituting, or alleged to constitute, a public record in accordance with the RTKL ("Requested Information"), Lessor shall:
 - a. Provide Lessee, within ten (10) calendar days after receipt of written notification, access to, and copies of, any document or information in Lessor's possession arising out of this Lease that Lessee reasonably believes is Requested Information and may be a public record under the RTKL; and \
 - b. Provide such other assistance as Lessee may reasonably request, in order to comply with the RTKL with respect to this Lease.
- 1.24.3 If Lessor considers the Requested Information to include a request for a Trade Secret or Confidential Proprietary Information, as those terms are defined by the RTKL, or other information that the Lessor considers exempt from production under the RTKL, Lessor must notify Lessee and provide, within seven (7) calendar days of receiving the written notification, a written statement signed by a representative of Lessor, explaining why the requested material is exempt from public disclosure under the RTKL.
- 1.24.4 Lessee will rely upon the written statement from Lessor in denying a RTKL request for the Requested Information unless Lessee determines that the Requested Information is clearly not protected from disclosure under the RTKL. Should Lessee determine that the Requested Information is clearly not exempt from disclosure, Lessor shall provide the Requested Information within five (5) business days of receipt of written notification of Lessee's determination.

- 1.24.5 If Lessor fails to provide the Requested Information within the time period required by these provisions, Lessor shall indemnify and hold Lessee harmless from any damages, penalties, costs, detriment, or harm that Lessee may incur as a result of Lessor's failure, including any statutory damages assessed against Lessee.
- 1.24.6 Lessee will reimburse Lessor for any costs associated with complying with these provisions only to the extent allowed under the fee schedule established by the Office of Open Records or as otherwise provided by the RTKL if the fee schedule is inapplicable.
- 1.24.7 Lessor may file a legal challenge to any Lessee decision to release a record to the public with the Office of Open Records, or in the Pennsylvania courts; however, Lessor shall indemnify Lessee for any legal expenses incurred by Lessee as a result of such a challenge and shall hold Lessee harmless from any damages, penalties, costs, detriment, or harm that Lessee may incur as a result of Lessor's failure, including any statutory damages assessed against Lessee, regardless of the outcome of such legal challenge. As between the parties, Lessor agrees to waive all rights or remedies that may be available to it as a result of Lessee's disclosure of Requested Information pursuant to the RTKL.
- 1.24.8 Lessor's duties relating to the RTKL are continuing duties that survive the expiration of this Lease and shall continue as long as Lessor has Requested Information in its possession.

1.25 Payments of Prevailing Minimum Wages

- 1.25.1 Lessor and Lessor's contractor(s) must comply with the following conditions, provisions, and requirements in the construction of the building, substantial rehabilitation of the building, and/or substantial alterations to the Premises:
 - a. Lessor and Lessor's contractors shall pay at least the wage rates as determined by the Secretary of the Pennsylvania Department of Labor and Industry and shall comply with the conditions of the Prevailing Wage Act of August 15, 1961, 43 P.S. § 165-1 et seq., and the regulations issued thereto, to assure the full and proper payment of the rates.
 - b. Workers in the construction of the building, substantial rehabilitation of the building, and/or substantial alterations to the Premises shall be paid at least the general prevailing minimum wage rates as set forth in the prevailing minimum wage predetermination, issued by the Secretary of Labor and Industry ("Secretary").
 - c. These requirements apply to work performed in the construction of the building, substantial rehabilitation of the building, and/or substantial alterations to the Premises by Lessor, Lessor's contractor(s), and all subcontractors.
 - d. Lessor shall insert in all its contracts for the construction of the building, substantial rehabilitation of the building, and/or substantial alterations to the Premises and shall require the contractor(s) to insert in each of its subcontracts the stipulations contained in these provisions.
- 1.25.2 No workers may be employed in the construction of the building, substantial rehabilitation of the building, and/or substantial alterations to the Premises except in accordance with the classifications in the prevailing minimum wage predetermination of the Secretary. If additional or different classifications are necessary, Lessor shall request the Department of General Services to petition the Secretary for rates for additional or different classifications.
- 1.25.3 Workers employed or working in the construction of the building, substantial rehabilitation of the building, and/or substantial alterations to the Premises shall be paid unconditionally, regardless of whether a contractual relationship exists or the nature of a contractual relationship that may be alleged to exist between a contractor, subcontractor, and worker, at least once a week, without deduction or rebate, on any account, either directly or indirectly except authorized deductions, the full amounts due at the time of payment, computed at the rates applicable to the time worked in the appropriate classification. Nothing in the lease, the Prevailing Wage Act, or the regulations promulgated pursuant to the Act prohibits the payment of more than the general prevailing minimum wage rates as determined by the Secretary to a worker on a public work.
- 1.25.4 Lessor shall require its contractor(s) and each subcontractor to post for the entire period of the construction of the building, substantial rehabilitation of the building, and/or substantial alterations to the Premises the wage determination decisions of the Secretary, including the effective date of changes thereof, in a prominent and easily accessible place or places at the site of the work and at the places used by them to pay workers their wages. The posted notice of wage rates shall contain the following information:
 - a. The name of project.
 - b. The name of the Using Agency that will be the tenant in the facility.
 - c. The crafts and classifications of workers listed in the Secretary's general prevailing minimum wage rate determination for the particular project.

- d. The general prevailing minimum wage rates determined for each craft and classification and the effective date of changes.
 - e. A statement advising workers that if they have been paid less than the general prevailing minimum wage rate for their job classification or that the contractor or subcontractor are not complying with the Prevailing Wage Act or this title, they may file a protest in writing with the Secretary within three (3) months of the date of the occurrence, objecting to the payment to a contractor to the extent of the amount due or to become due to them as wages for work performed on the public work project. A worker paid less than the rate specified in the contract shall have a civil right to action for the difference between the wage paid and the wages stipulated in the contract, which right of action shall be exercised within six (6) months from the occurrence of the event creating the right.
- 1.25.5 Lessor shall require its contractor(s) and each subcontractor to keep an accurate record showing the name, craft or classification, number of hours worked per day, and the actual hourly rate of wage paid, including employee benefits, to each worker employed by him in connection with the public work. The record shall include deductions from each worker. The record shall be preserved for two (2) years from the date of payment and shall be open at reasonable hours to the inspection of the Department of General Services and the Department of Labor and Industry.
 - 1.25.6 Apprentices shall be limited to numbers in accordance with a bona fide apprenticeship program registered with and approved by The Pennsylvania Apprenticeship and Training Council and only apprentices whose training and employment are in full compliance with The Apprenticeship and Training Act (43 P.S. §§ 90.1-90.10), approved July 14, 1961, and the regulations issued thereto shall be employed on the public work project. A worker using the tools of a craft who does not qualify as an apprentice within this paragraph shall be paid the rate predetermined for journeymen in that particular craft or classification.
 - 1.25.7 Wages shall be paid without deductions except authorized deductions. Employers not parties to a contract requiring contributions for employee benefits, which the Secretary has determined to be included in the general prevailing minimum wage rate, shall pay the monetary equivalent thereof directly to the workers.
 - 1.25.8 Payment of compensation to workers for work performed on public work on a lump sum basis, or a piece work system, or a price certain for the completion of a certain amount of work, or the production of a certain result shall be deemed a violation of the Prevailing Wage Act and the Lease, regardless of the average hourly earnings resulting therefrom.
 - 1.25.9 Lessor shall require its contractor(s) and each subcontractor to file a statement each week and a final statement at the conclusion of the work on the contract under oath, and in form satisfactory to the Secretary, certifying that workers have been paid wages in strict conformity with the provisions of the contract as prescribed by this provision or if wages remain unpaid to set forth the amount of wages due and owing to each worker respectively.
 - 1.25.10 The provisions of the Prevailing Wage Act (43 P.S. §§ 165-1 through 165-17) and the regulations issued thereto (34 Pa. Code §§ 9.101 through 9.112) are incorporated by reference in the Lease.
 - 1.25.11 As used in this paragraph, "substantial rehabilitation" is the conversion or adaptation of an existing facility into a safe, structurally sound building, by gutting and extensive re-construction, to make the building suitable for use by Lessee.
 - 1.25.12 As used in this paragraph, "substantial alterations" are those alterations to an existing facility by Lessor in accordance with the specifications, plans, or drawings contained in the Lease or where the final plans, drawings, or specifications must be reviewed and approved by Lessee.

1.26 Accessibility to the Premises by Individuals with Disabilities

For the purpose of these provisions, the term Contractor is defined as any person, including, but not limited to, a bidder, offeror, supplier, or grantee, who will furnish or perform or seeks to furnish or perform, goods, supplies, services, construction, or other activity, under a purchase order, contract, or grant with the Commonwealth.

During the term of this agreement, the Contractor agrees as follows:

- 1.26.1 Pursuant to federal regulations promulgated under the authority of the Americans with Disabilities Act, 28 C. F. R. § 35.101 et seq., the Contractor understands and agrees that no individual with a disability shall, on the basis of the disability, be excluded from participation in this agreement or from activities provided for under this agreement. As a condition of accepting and executing this agreement, the Contractor agrees to comply with the "General Prohibitions Against Discrimination," 28 C. F. R. § 35.130, and all other regulations promulgated under Title II of the Americans with Disabilities Act that are applicable to the benefits, services, programs, and activities provided by the Commonwealth through contracts with outside contractors.

- 1.26.2 The Contractor shall be responsible for and agrees to indemnify and hold harmless the Commonwealth from all losses, damages, expenses, claims, demands, suits, and actions brought by any party against the Commonwealth as a result of the Contractor's failure to comply with the provisions of this paragraph.

1.27 Contractor Integrity Provisions

The word "Contractor" as used herein shall refer to Lessor. It is essential that those who seek to contract with the Commonwealth observe high standards of honesty and integrity. They must conduct themselves in a manner that fosters public confidence in the integrity of the Commonwealth procurement process.

- 1.27.1 **DEFINITIONS.** For purposes of these Contractor Integrity Provisions, the following terms shall have the meanings found in this Section:
- a. **"Affiliate"** means two or more entities where (a) a parent entity owns more than fifty percent of the voting stock of each of the entities; or (b) a common shareholder or group of shareholders owns more than fifty percent of the voting stock of each of the entities; or (c) the entities have a common proprietor or general partner.
 - b. **"Consent"** means written permission signed by a duly authorized officer or employee of the Commonwealth, provided that where the material facts have been disclosed, in writing, by prequalification, bid, proposal, or contractual terms, the Commonwealth shall be deemed to have consented by virtue of the execution of this contract.
 - c. **"Contractor"** means the individual or entity, that has entered into this contract with the Commonwealth.
 - d. **"Contractor Related Parties"** means any affiliates of the Contractor and the Contractor's executive officers, Pennsylvania officers and directors, or owners of 5 percent or more interest in the Contractor.
 - e. **"Financial Interest"** means either:
 - Ownership of more than a five percent interest in any business; or
 - Holding a position as an officer, director, trustee, partner, employee, or holding any position of management.
 - f. **"Gratuity"** means tendering, giving, or providing anything of more than nominal monetary value including, but not limited to, cash, travel, entertainment, gifts, meals, lodging, loans, subscriptions, advances, deposits of money, services, employment, or contracts of any kind. The exceptions set forth in the Governor's Code of Conduct, Executive Order 1980-18, the 4 Pa. Code §7.153(b), shall apply.
 - g. **"Non-bid Basis"** means a contract awarded or executed by the Commonwealth with Contractor without seeking bids or proposals from any other potential bidder or offeror.

In furtherance of this policy, Contractor agrees to the following:

- 1.27.2 Contractor shall maintain the highest standards of honesty and integrity during the performance of this contract and shall take no action in violation of federal or state laws or regulations or any other applicable laws or regulations, or other requirements applicable to Contractor or that govern contracting or procurement with the Commonwealth.
- 1.27.3 Contractor shall establish and implement a written business integrity policy, which includes, at a minimum, the requirements of these provisions as they relate to the Contractor activity with the Commonwealth and Commonwealth employees and which is made known to all Contractor employees. Posting these Contractor Integrity Provisions conspicuously in easily accessible and well-lighted places customarily frequented by employees and at or near where the contract services are performed shall satisfy this requirement.
- 1.27.4 Contractor, its affiliates, agents, employees, and anyone in privity with Contractor shall not accept, agree to give, offer, confer, or agree to confer or promise to confer, directly or indirectly, any gratuity or pecuniary benefit to any person, or to influence or attempt to influence any person in violation of any federal or state law, regulation, executive order of the Governor of Pennsylvania, statement of policy, management directive, or any other published standard of the Commonwealth in connection with performance of work under this contract, except as provided in this contract.
- 1.27.5 Contractor shall not have a financial interest in any other contractor, subcontractor, or supplier providing services, labor, or material under this contract, unless the financial interest is disclosed to the Commonwealth in writing and

the Commonwealth consents to Contractor's financial interest prior to Commonwealth execution of the contract. Contractor shall disclose the financial interest to the Commonwealth at the time of bid or proposal submission, or if no bids or proposals are solicited, no later than Contractor's submission of the contract signed by Contractor.

- 1.27.6 Contractor certifies to the best of its knowledge and belief that within the last five (5) years, Contractor or Contractor Related Parties have not:
- a. Been indicted or convicted of a crime involving moral turpitude or business honesty or integrity in any jurisdiction;
 - b. Been suspended, debarred or otherwise disqualified from entering into any contract with any governmental agency;
 - c. Had any business license or professional license suspended or revoked;
 - d. Had any sanction or finding of fact imposed as a result of a judicial or administrative proceeding related to fraud, extortion, bribery, bid rigging, embezzlement, misrepresentation, or anti-trust; and
 - e. Been, and is not currently, the subject of a criminal investigation by any federal, state, or local prosecuting or investigative agency and/or civil anti-trust investigation by any federal, state, or local prosecuting or investigative agency.
- 1.27.7 If Contractor cannot so certify to the above then it must submit along with its bid, proposal, or contract a written explanation of why such certification cannot be made and the Commonwealth will determine whether a contract may be entered into with the Contractor. The Contractor's obligation pursuant to this certification is ongoing from and after the effective date of the contract through the termination date thereof. Accordingly, the Contractor shall have an obligation to immediately notify the Commonwealth in writing if at any time during the term of the contract it becomes aware of any event that would cause the Contractor's certification or explanation to change. Contractor acknowledges that the Commonwealth may, in its sole discretion, terminate the contract for cause if it learns that any of the certifications made herein are currently false due to intervening factual circumstances or were false or should have been known to be false when entering into the contract.
- 1.27.8 Contractor shall comply with the requirements of the Lobbying Disclosure Act (65 Pa.C.S. §13A01 et seq.) regardless of the method of award. If this contract was awarded on a Non-bid Basis, Contractor must also comply with the requirements of the Section 1641 of the Pennsylvania Election Code (25 P.S. §3260a).
- 1.27.9 When Contractor has reason to believe that any breach of ethical standards as set forth in law, the Governor's Code of Conduct, or these Contractor Integrity Provisions has occurred or may occur, including but not limited to contact by a Commonwealth officer or employee which, if acted upon, would violate such ethical standards, Contractor shall immediately notify the Commonwealth contracting officer or the Office of the State Inspector General in writing.
- 1.27.10 Contractor, by submission of its bid or proposal and/or execution of this contract and by the submission of any bills, invoices, or requests for payment pursuant to the contract, certifies and represents that it has not violated any of these Contractor Integrity Provisions in connection with the submission of the bid or proposal, during any contract negotiations or during the term of the contract, to include any extensions thereof. Contractor shall immediately notify the Commonwealth in writing of any actions or occurrences that would result in a violation of these Contractor Integrity Provisions. Contractor agrees to reimburse the Commonwealth for the reasonable costs of investigation incurred by the Office of the State Inspector General for investigations of the Contractor's compliance with the terms of this or any other agreement between the Contractor and the Commonwealth that results in the suspension or debarment of the Contractor. Contractor shall not be responsible for investigative costs for investigations that do not result in the Contractor's suspension or debarment.
- 1.27.11 Contractor shall cooperate with the Office of the State Inspector General in its investigation of any alleged Commonwealth agency or employee breach of ethical standards and any alleged Contractor non-compliance with these Contractor Integrity Provisions. Contractor agrees to make identified Contractor employees available for interviews at reasonable times and places. Contractor, upon the inquiry or request of an Inspector General, shall provide, or if appropriate, make promptly available for inspection or copying, any information of any type or form deemed relevant by the Office of the State Inspector General to Contractor's integrity and compliance with these provisions. Such information may include, but shall not be limited to, Contractor's business or financial records, documents, or files of any type or form that refer to or concern this contract. Contractor shall incorporate this paragraph in any agreement, contract, or subcontract it enters into in the course of the performance of this contract/agreement solely for the purpose of obtaining subcontractor compliance with this provision. The incorporation of this provision in a subcontract shall not create privity of contract between the Commonwealth and any such subcontractor, and no third-party beneficiaries shall be created thereby.
- 1.27.12 For violation of any of these Contractor Integrity Provisions, the Commonwealth may terminate this and any other contract with Contractor, claim liquidated damages in an amount equal to the value of anything received in breach

of these Provisions, claim damages for all additional costs and expenses incurred in obtaining another contractor to complete performance under this contract, and debar and suspend Contractor from doing business with the Commonwealth. These rights and remedies are cumulative, and the use or non-use of any one shall not preclude the use of all or any other. These rights and remedies are in addition to those the Commonwealth may have under law, statute, regulation, or otherwise.

1.28 Contractor Responsibility Provisions

For the purpose of these provisions, the term contractor is defined as any person, including, but not limited to, a bidder, offeror, loan recipient, grantee, or lessor, who has furnished or performed or seeks to furnish or perform, goods, supplies, services, leased space, construction, or other activity, under a contract, grant, lease, purchase order, or reimbursement agreement with the Commonwealth. The term contractor includes a permittee, licensee, or any agency, political subdivision, instrumentality, public authority, or other public entity in the Commonwealth.

- 1.28.1 The Contractor certifies, in writing, for itself and its subcontractors required to be disclosed or approved by the Commonwealth, that as of the date of its execution of this Bid/Contract, that neither the Contractor, nor any such subcontractors, are under suspension or debarment by the Commonwealth or any governmental entity, instrumentality, or authority and, if the Contractor cannot so certify, then it agrees to submit, along with the Bid/Contract, a written explanation of why such certification cannot be made.
- 1.28.2 The Contractor also certifies, in writing, that as of the date of its execution of this Bid/Contract it has no tax liabilities or other Commonwealth obligations or has filed a timely administrative or judicial appeal if such liabilities or obligations exist or is subject to a duly approved deferred payment plan if such liabilities exist.
- 1.28.3 The Contractor's obligations pursuant to these provisions are ongoing from and after the effective date of the Contract through the termination date thereof. Accordingly, the Contractor shall have an obligation to inform the Commonwealth if, at any time during the term of the Contract, it becomes delinquent in the payment of taxes, or other Commonwealth obligations, or if it or, to the best knowledge of the Contractor, any of its subcontractors are suspended or debarred by the Commonwealth, the federal government, or any other state or governmental entity. Such notification shall be made within fifteen (15) days of the date of suspension or debarment.
- 1.28.4 The failure of the Contractor to notify the Commonwealth of its suspension or debarment by the Commonwealth, any other state, or the federal government shall constitute an event of default of the Contract with the Commonwealth.
- 1.28.5 The Contractor agrees to reimburse the Commonwealth for the reasonable costs of investigation incurred by the Office of State Inspector General for investigations of the Contractor's compliance with the terms of this or any other agreement between the Contractor and the Commonwealth that results in the suspension or debarment of the contractor. Such costs shall include, but shall not be limited to, salaries of investigators, including overtime; travel and lodging expenses; and expert witness and documentary fees. The Contractor shall not be responsible for investigative costs for investigations that do not result in the Contractor's suspension or debarment.
- 1.28.6 The Contractor may obtain current list of suspended and debarred Commonwealth contractors by either searching the Internet at <http://www.dgs.state.pa.us/debarment.htm> or contacting the Department of General Services, Office of Chief Counsel, 603 North Office Building, Harrisburg, PA 17125 (telephone no. 717-783-6472, fax no. 717-787-9138).

1.29 Offset Provisions

The Lessor agrees that the Commonwealth may set off the amount of any state tax liability or other obligation of the Lessor or its subsidiaries to the Commonwealth against any payments due the Lessor under any contract with the Commonwealth.

1.30 Nondiscrimination/Sexual Harassment Clause

The word "Contractor" as used herein shall refer to Lessor. The Contractor agrees:

- 1.30.1 In the hiring of any employee(s) for the manufacture of supplies, performance of work, or any other activity required under the contract or any subcontract, the Contractor, each subcontractor, or any person acting on behalf of the Contractor or subcontractor shall not discriminate by reason of race, gender, creed, color, sexual orientation, gender identity or expression, or in violation of the Pennsylvania Human Relations Act (PHRA) and applicable federal laws, against any citizen of this Commonwealth who is qualified and available to perform the work to which the employment relates.
- 1.30.2 Neither the Contractor nor any subcontractor nor any person on their behalf shall in any manner discriminate by reason of race, gender, creed, color, sexual orientation, gender identity or expression, or in violation of the PHRA

and applicable federal laws, against or intimidate any employee involved in the manufacture of supplies, the performance of work, or any other activity required under the contract.

- 1.30.3 Neither the Contractor nor any subcontractor nor any person on their behalf shall in any manner discriminate by reason of race, gender, creed, color, sexual orientation, gender identity or expression, or in violation of the PHRA and applicable federal laws, in the provision of services under the contract.
- 1.30.4 Neither the Contractor nor any subcontractor nor any person on their behalf shall in any manner discriminate against employees by reason of participation in or decision to refrain from participating in labor activities protected under the Public Employee Relations Act, Pennsylvania Labor Relations Act or National Labor Relations Act, as applicable and to the extent determined by entities charged with such Acts' enforcement, and shall comply with any provision of law establishing organizations as employees' exclusive representatives.
- 1.30.5 The Contractor and each subcontractor shall establish and maintain a written nondiscrimination and sexual harassment policy and shall inform their employees in writing of the policy. The policy must contain a provision that sexual harassment will not be tolerated and employees who practice it will be disciplined. Posting this Nondiscrimination/Sexual Harassment Clause conspicuously in easily-accessible and well-lighted places customarily frequented by employees and at or near where the contracted services are performed shall satisfy this requirement for employees with an established work site.
- 1.30.6 The Contractor and each subcontractor shall not discriminate by reason of race, gender, creed, color, sexual orientation, gender identity or expression, or in violation of PHRA and applicable federal laws, against any subcontractor or supplier who is qualified to perform the work to which the contract relates.
- 1.30.7 The Contractor and each subcontractor represents that it is presently in compliance with and will maintain compliance with all applicable federal, state, and local laws, regulations and policies relating to nondiscrimination and sexual harassment. The Contractor and each subcontractor further represents that it has filed a Standard Form 100 Employer Information Report ("EEO-1") with the U.S. Equal Employment Opportunity Commission ("EEOC") and shall file an annual EEO-1 report with the EEOC as required for employers' subject to Title VII of the Civil Rights Act of 1964, as amended, that have 100 or more employees and employers that have federal government contracts or first-tier subcontracts and have 50 or more employees. The Contractor and each subcontractor shall, upon request and within the time periods requested by the Commonwealth, furnish all necessary employment documents and records, including EEO-1 reports, and permit access to their books, records, and accounts by the contracting agency and the Bureau of Diversity, Inclusion and Small Business Opportunities for purpose of ascertaining compliance with provisions of this Nondiscrimination/Sexual Harassment Clause.
- 1.30.8 The Contractor shall include the provisions of this Nondiscrimination/Sexual Harassment Clause in every subcontract so that those provisions applicable to subcontractors will be binding upon each subcontractor.
- 1.30.9 The Contractor's and each subcontractor's obligations pursuant to these provisions are ongoing from and after the effective date of the contract through the termination date thereof. Accordingly, the Contractor and each subcontractor shall have an obligation to inform the Commonwealth if, at any time during the term of the contract, it becomes aware of any actions or occurrences that would result in violation of these provisions.
- 1.30.10 The Commonwealth may cancel or terminate the contract and all money due or to become due under the contract may be forfeited for a violation of the terms and conditions of this Nondiscrimination/Sexual Harassment Clause. In addition, the agency may proceed with debarment or suspension and may place the Contractor in the Contractor Responsibility File.

1.31 Enhanced Minimum Wage Provisions

- 1.31.1 Enhanced Minimum Wage. Contractor/Lessor agrees to pay no less than \$12.00 per hour to its employees for all hours worked directly performing the services called for in this Contract/Lease, and for an employee's hours performing ancillary services necessary for the performance of the contracted services or lease when such employee spends at least twenty per cent (20%) of their time performing ancillary services in a given work week.
- 1.31.2 Adjustment. Beginning July 1, 2019, and annually thereafter, the minimum wage rate shall be increased by \$0.50 until July 1, 2024, when the minimum wage reaches \$15.00. Thereafter, the minimum wage rate would be increased by an annual cost-of-living adjustment using the percentage change in the Consumer Price Index for All Urban Consumers (CPI-U) for Pennsylvania, New Jersey, Delaware, and Maryland. The applicable adjusted amount shall be published in the Pennsylvania Bulletin by March 1 of each year to be effective the following July 1.
- 1.31.3 Exceptions. These Enhanced Minimum Wage Provisions shall not apply to employees: exempt from the minimum wage under the Minimum Wage Act of 1968; covered by a collective bargaining agreement; required to be paid a higher wage under another state or federal law governing the services, including the Prevailing Wage Act and Davis-Bacon Act; or required to be paid a higher wage under any state or local policy or ordinance.

- 1.31.4 Notice. Contractor/Lessor shall post these Enhanced Minimum Wage Provisions for the entire period of the contract conspicuously in easily-accessible and well-lighted places customarily frequented by employees at or near where the contracted services are performed.
- 1.31.5 Records. Contractor/Lessor must maintain and, upon request and within the time periods requested by the Commonwealth, furnish all employment and wage records necessary to document compliance with these Enhanced Minimum Wage Provisions.
- 1.31.6 Sanctions. Failure to comply with these Enhanced Minimum Wage Provisions may result in the imposition of sanctions, which may include, but shall not be limited to, termination of the contract or lease, nonpayment, debarment or referral to the Office of General Counsel for appropriate civil or criminal referral.
- 1.31.7 Subcontractors. Contractor/Lessor shall include the provisions of these Enhanced Minimum Wage Provisions in every subcontract so that these provisions will be binding upon each subcontractor.

1.32 Notice

Any notice or demand from Lessee to Lessor or from Lessor to Lessee shall be in writing and shall be delivered by hand or by deposit in United States mail, postage prepaid, via registered or certified mail, with an additional copy sent via email when available. If the Notice is to the Lessor, it should be placed in an envelope addressed to the attention of the Lessor Contact identified on the Lease Cover Sheet. If the Notice is to the Lessee, it should be placed in an envelope addressed to the Director, Bureau of Real Estate at the address listed on the Lease Cover Sheet.

1.33 Events of Default

Any one or more of the following events shall constitute an "Event of Default":

- a. Failure of Lessor to provide the services as stipulated in this Lease.
- b. Failure of Lessor to maintain the Premises in a safe and tenantable condition.
- c. Failure of Lessor to provide peaceful and uninterrupted possession of the Premises by Lessee.
- d. Failure of Lessor to notify Lessee of transfer of the Lease prior to receiving Lessee's written approval to assign the Lease.
- e. Failure of Lessor to perform or observe any of the obligations or any other covenants, terms, or conditions contained in this Lease.

1.34 Remedies of Lessee

Upon the occurrence and continuance of an Event of Default by Lessor, Lessee may, after giving Lessor a thirty (30) day written notice, except as modified as set forth herein, exercise one or more of the following remedies:

- 1.34.1 If any Event of Default by Lessor results in a material disruption in Lessee's business operations at the Premises of longer than twenty-four (24) hours, and/or poses a risk of material injury or damage to persons or property, and Lessee has notified Lessor of the disruption in Lessee's operations and/or risk with a reasonable request to cure within a shorter time period than thirty (30) days as to ensure that Lessee does not continue to experience disruption in their operations or further risk of damage, and Lessor fails to cure within the time period stated in said notice, then Lessee may cure, with written notice to the Lessor, the Event of Default, at Lessor's sole cost and expense in accordance with the following:
 - a. Lessor shall reimburse Lessee for reasonable costs and expenses, including but not limited to costs incurred due to a temporary relocation of Lessee in connection with Lessee curing the Event of Default together with interest on the amount of such costs and expenses at a rate of 10 percent (10%) per annum from the date such costs and expenses were incurred. Such reimbursement shall be made within ten (10) days after Lessor receives an invoice from Lessee detailing the costs and expenses of the cure. If Lessor fails to pay the Lessee the full amount, as evidenced in the invoice from Lessee, within ten (10) days after receipt of the invoice, then Lessee shall have the right to set off the full amount due to Lessee against the Rent. Lessor shall continue to be liable to Lessee for any amounts Lessee elects not to offset against rent.
 - b. Lessee shall not be liable to Lessor for the manner in which Lessee performs Lessor's obligations under this paragraph; and Lessor releases Lessee of any liability of any nature related to such performance. Lessee's performance of a Lessor obligation under this paragraph shall not relieve Lessor from thereafter performing that obligation.
- 1.34.2 Terminate this Lease and the tenancy created hereby.
- 1.34.3 Abate payment of Rent for as long as the Event of Default remains in effect. After corrective action has been completed by Lessor, Lessee shall pay Lessor the withheld Rent less any costs and expenses, including but not

limited to, costs incurred for any and all temporary relocation(s) of Lessee as a result of the Event of Default suffered by Lessee. Additionally, Lessee, in its sole discretion, may permanently abate the value of the service(s) not provided by Lessee.

- 1.34.4 The thirty (30) day notice requirement imposed by Lessee in this paragraph does not apply where the Event of Default results in Lessee's vacating the Premises. In such an event, the Lessor's thirty (30) day period to cure begins immediately upon the occurrence of the Event of Default notwithstanding that Lessor's written default notice may be sent after the occurrence of the Event of Default.
- 1.34.5 Lessee, in its sole discretion, may immediately and permanently abate Rent for the period Lessee is constructively evicted from the Premises.
- 1.34.6 Notwithstanding any other provision of this Lease, Lessee in its sole discretion may terminate this Lease and the tenancy created hereby in the event there are three (3) or more Events of Default within any three-hundred sixty-five- (365) day period, regardless of whether Lessor cures the defaults in accordance with this paragraph.
- 1.34.7 The Remedies of Lessee set forth in this paragraph shall be in addition to all other remedies available at law or equity to Lessee for any default by Lessor under this Lease.

1.35 No Waiver of Rights

The failure by Lessee to require performance of any provision of this Lease shall not affect Lessee's right to require performance at any time thereafter. Further, a waiver of any breach or default of this Lease shall not constitute a waiver of any subsequent breach or default or a waiver of the provision itself.

1.36 Disputes

- 1.36.1 In the event of a controversy or claim arising from the Lease:
 - a. Lessor shall, within six (6) months after the cause of action accrues, file a written claim with the Director of the Bureau of Real Estate, Department of General Services, for a determination. The claim shall state all grounds upon which Lessor asserts a dispute exists.
 - b. If Lessor fails to file a claim or files an untimely claim, Lessor acknowledges and agrees that they have waived their right to assert a claim in any forum.
- 1.36.2 At the time the claim is filed, or within sixty (60) days thereafter, either party may request mediation through the Commonwealth Office of General Counsel Dispute Resolution Program.
 - a. If Lessor or the Director of the Bureau of Real Estate requests mediation and the other party agrees, the Director of the Bureau of Real Estate shall promptly make arrangements for mediation.
 - b. Mediation shall be scheduled so as to not delay the issuance of the final determination beyond the required one hundred twenty (120) days after receipt of the claim if mediation is unsuccessful.
- 1.36.3 If mediation is not agreed to or if a resolution is not reached through mediation, the Director of the Bureau of Real Estate shall review any timely filed claim and issue a final determination, in writing, regarding the claim.
- 1.36.4 The final determination shall be issued within one hundred twenty (120) days of the receipt of the claim, unless extended by consent of Lessee and the Lessor. The Director of the Bureau of Real Estate shall send the written determination to Lessor.
 - a. If the Director of the Bureau of Real Estate fails to issue a final determination within one hundred twenty (120) days (unless extended by consent of the parties), the claim shall be deemed denied.
 - b. The determination of the Director of the Bureau of Real Estate shall be the final order of the Department of General Services.
- 1.36.5 Within fifteen (15) days of the mailing date of the determination denying a claim, or within one hundred thirty-five (135) days of filing a claim, if no extension is agreed to by the parties, whichever occurs first, Lessor may file a statement of claim with the Commonwealth Board of Claims.
- 1.36.6 Pending a final judicial resolution of a controversy or claim, Lessor shall proceed diligently with the performance of this Lease in a manner consistent with the determination of the Director of the Bureau of Real Estate.
- 1.36.7 Notwithstanding anything herein to the contrary, Lessee expressly reserves its rights to file any claim against Lessor in any forum of their choice including, but not limited to, the Commonwealth Board of Claims, Commonwealth Court, Dauphin County or any other county court, and the U.S. District Court for the Middle District of Pennsylvania.

1.37 Modifications to the Lease

This Lease shall not be modified, amended, or rescinded orally. This Lease supersedes all prior agreements, discussions, and understandings, both written and oral, between the parties with respect to this Lease. Any and all modifications to the Lease must be done by a Lease Amendment that is signed by both parties and approved by the Board of Commissioners of Public Grounds and Buildings, the Secretary of the Department of General Services, or via Consent Form or LHI Change Order.

1.38 Choice of Law

This Lease shall be governed by and interpreted and enforced in accordance with the laws of the Commonwealth of Pennsylvania (without regard to any conflict of laws provisions) and the decisions of the Pennsylvania courts. The Lessor consents to the jurisdiction of any court of the Commonwealth of Pennsylvania and any federal courts in Pennsylvania, waiving any claim or defense that such forum is not convenient or proper. The Lessor agrees that any such court shall have in personam jurisdiction over it, and consents to service of process in any manner authorized by Pennsylvania law.

1.39 Review of Lease

The parties acknowledge that each party and its respective counsel have reviewed this Lease and that no rule of construction to the effect that any ambiguities are to be resolved against the drafting party shall be employed in the interpretation of this Lease or any Amendment or Exhibits hereto.

1.40 Execution

Lessor agrees and acknowledges that this Lease is subject to approval by the Board of Commissioners of Public Grounds and Buildings and final execution by the Secretary of the Department of General Services.

1.41 Time is of the Essence

Time is of the essence of all provisions of the Lease, including all Notice Provisions, to be performed by or on behalf of Lessor and Lessee.

1.42 Binding Successors and Assigns

All rights and liabilities herein given to, or imposed upon, the respective parties hereto shall extend to and bind the several respective successors and permitted assigns of the parties.

1.43 Survival

The expiration of the Lease, whether by lapse of time or otherwise, shall not relieve either party of any obligations which accrued prior to, or which may continue to accrue, after the expiration of or early termination of this Lease.

1.44 Conflicts Within the Lease

To the extent that there are any conflicts between the Lease Cover Sheet, any Lease sections, and any Exhibits within the Lease, the Lease Cover Sheet shall take priority. For all other conflicts, Lessor shall maintain/construct the Premises in accordance with the most stringent standard.

1.45 Integration

This Lease, including all referenced Exhibits, which are incorporated herein and made a part hereof, constitutes the entire agreement between the parties. No agent, representative, employee, or officer of Lessor or Lessee has the authority to make, or has made, any statement, agreement, or representation, oral or written, in connection with this Lease, which in any way can be deemed to modify, add to, or detract from, or otherwise change or alter its terms and conditions. No negotiations between the parties, nor any custom or usage, shall be permitted to modify or contradict any of the terms and conditions of this Lease. No modifications, alterations, changes, or waiver to this Lease or any of its terms shall be valid or binding unless accomplished by a written Amendment, Consent Form or LHI Change Order signed by both parties.

1.46 Force Majeure

Neither party shall be liable to the other for any delayed performance under the Lease arising out of or resulting from delay due in whole or in part to flood, storms or other act of God, strike, lock out, labor action, riot, act of war, civil commotion, government regulation or order, utility failures, or other cause beyond the reasonable control of the party.

1.47 Surrender of Premise

At the expiration or earlier termination of this Lease, Lessee shall return the Premises to Lessor in satisfactory condition, ordinary wear and tear, and damage by fire or other casualty excepted. Lessee shall remove all property belonging to Lessee, leaving property free of debris and broom-swept, and deliver all keys to Lessor. Representatives of Lessee and Lessor shall together examine the Premises. Lessor shall remove all exterior building signage within thirty (30) days of the termination of the lease.

1.48 Exhibits Part of Lease

Included in and made a part of this Lease, with the same force and effect as though fully set forth in this Lease are Exhibits 1–3.

- a. Exhibit 1—Acceptance of Leased Premises Inspection Report (GSRE-42-N)
- b. Exhibit 2—Leasehold Improvement Consent Form
- c. Exhibit 3—Leasehold Improvement Change Order
- d. Exhibit 4-- Test Fit Out Floor Plan

EXHIBIT 1

ACCEPTANCE OF LEASED PREMISES AND/OR RENOVATIONS INSPECTION REPORT

LESSOR:

(NAME)

(STREET) (CITY) (COUNTY)

LOCATION:

(STREET) (CITY) (COUNTY)

USING AGENCY:

(DEPARTMENT) (BUREAU)

This is to certify that I have visually inspected the above Premises on _____ and find that the
(DATE)
Premises are built and/or renovated in accordance with the requirements of Lease _____, with the exception of
(LEASE #)

the following items:

1. _____
2. _____
3. _____
4. _____
5. _____

(additional items on attached sheet, if necessary)

The _____ hereby accepts the above Premises for occupancy effective _____
(USING AGENCY) (ACCEPTANCE DATE)

and approves the _____ New Construction _____ Renovations excepting the above items.

Further, _____ agrees that _____ is to be the effective date of
(USING AGENCY) (ACCEPTANCE DATE)

occupancy; that the rental for the above mentioned property shall commence on that date, that the lease term, upon the execution of this document by all parties, shall extend for _____ years from the Acceptance Date; with any option terms provided for in the lease being adjusted accordingly.

(USING AGENCY REPRESENTATIVE)

(TITLE)

(USING AGENCY)

I understand and agree to the foregoing and I certify, as Lessor of the above referenced Premises, that completion of the excepted items as stated herein shall be no later than _____. I also acknowledge and agree that, should I fail to complete any of those items within the above timeframe, then the Lessee may, at its discretion, withhold rental payments. I hereby agree to the adjustment in the Lease and option terms described above.

(LESSOR)

Copy to DGS _____
(DATE)

Copy to Treasury _____
(DATE)

Copy to Comptroller _____
(DATE)

EXHIBIT 2

LEASEHOLD IMPROVEMENT CONSENT FORM

LEASE #: _____ (“Lease”)

FRE CONTRACT #: _____

LESSOR: _____

USING AGENCY:

PREMISES ADDRESS: _____

COUNTY: _____

Lessor hereby consents and otherwise authorizes Lessee and/or its contractor(s) to make Leasehold Improvements¹ to the Premises² as defined and illustrated on the attached plan(s) and/or scope of work.

The total cost of the Leasehold Improvement(s) shall not exceed \$_____ and shall be borne in full by Lessee³.

Lessor understands and agrees that any items installed by Lessee shall remain the property of the Lessee and be maintained by Lessee unless otherwise negotiated between the parties. Additionally, any items installed by Lessee may be removed by the Lessee, at Lessee’s discretion, provided that the Premises are restored in substantially the same condition as it was prior to completion of the Leasehold Improvement(s), ordinary wear and tear excepted.

Lessor understands and agrees that this Consent Form is not fully executed until the Lessor and Lessee have signed.

LESSOR:

LESSEE:

Commonwealth of Pennsylvania, acting through
the Department of General Services

By:

By:

Print Name:

Print Name: Tracy M. Surfield

Title:

Title: Leasing Division Chief

FOR DGS/BRE USE ONLY:

This Consent Form is executed on this _____ day of _____, 20____.

¹ Additions, alterations or improvements made to the Premises, which occur after the Commencement Date of the Lease.

² The property, as defined and clarified in the Lease Agreement, that is owned and/or controlled by the Lessor and is leased to the Lessee.

³ The Commonwealth of Pennsylvania, acting through the Department of General Services, on behalf of the Using Agency.

EXHIBIT 3



COMMONWEALTH OF PENNSYLVANIA
DEPARTMENT OF GENERAL SERVICES
HARRISBURG

LEASEHOLD IMPROVEMENT CHANGE ORDER # FOR LEASE #

THIS LEASEHOLD IMPROVEMENT CHANGE ORDER (CHANGE ORDER) is between the Commonwealth of Pennsylvania, acting through the Department of General Services (LESSEE), and (LESSOR).

LESSOR, at the request of, and for the benefit of the LESSEE, will provide Leasehold Improvements⁴ to the Premises⁵ in accordance with the plans and specifications illustrated in Exhibit CO- A and pursuant to Exhibit CO- B, Acceptance of Renovations Inspection Report. LESSOR agrees to furnish all labor and materials in order to complete the Leasehold Improvements included within the scope of this CHANGE ORDER.

Work listed and described in Exhibit CO-2A shall be completed by a licensed contractor with proof of insurance within sixty (60) days of the full execution of this CHANGE ORDER. Work will be completed with minimum disruption to the workplace at times agreed upon by LESSEE. Upon completion and acceptance by LESSEE pursuant to Exhibit CO- B, LESSEE agrees to pay LESSOR a one-time lump sum payment for the actual costs incurred not to exceed \$. LESSOR shall invoice LESSEE for actual costs incurred within 30 days following completion of the work.

⁴ Additions, alterations or improvements made to the Premises, which occur after the Commencement Date of the Lease.

⁵ The property, as defined and clarified in the Lease Agreement, that is owned by the Lessor and is leased to the Lessee.

IN WITNESS WHEREOF, the parties hereto have duly executed this LEASEHOLD IMPROVEMENT CHANGE ORDER as of _____, 20____.

LESSOR:

Date: _____

LESSEE:

Commonwealth of Pennsylvania,
acting through the Department of General Services

Date: _____

Elizabeth N. Christian, Director
Bureau of Real Estate

Distribution: Agency Comptroller and/or Treasury Department

*For Leasehold Improvements that are estimated at \$50,000.00 or less, this Leasehold Improvement Change Order shall be signed by the Director of the Bureau of Real Estate.

**Leasehold Improvements that are estimated at \$50,000.01 and over must be accomplished through execution of a formal Lease Amendment.

2 SERVICES AND MAINTENANCE

2.1 Provision of Services, Access, and Normal Hours of Operation

The Lessee's normal hours of operation are established as 7:00 a.m. to 7:00 p.m., Monday through Friday, with the exception of state holidays unless otherwise specified on the Lease Cover Sheet or in Section 4. Services, maintenance, and utilities shall be provided during these hours. The Lessee shall have access to, and use of, the Premises at all times without additional payment, including the use of necessary services and utilities such as elevators, restrooms, lights, and electric power. Cleaning shall be performed during normal hours of operation.

2.2 On-Site Lessor Management

The Lessor shall provide an on-site building superintendent or a locally designated representative available to promptly respond to deficiencies and immediately address all emergency situations. It is the responsibility of the Lessor to ensure adequate communication to the Lessee relevant to any situation impacting the Premises.

2.3 Identity Verification of Personnel

- 2.3.1 The Lessee reserves the right to verify identities of personnel with routine pre-occupancy and/or unaccompanied access to the Premises.
- 2.3.2 The Lessee reserves the right to conduct additional background checks on Lessor personnel and contractors with routine access to the Premises throughout the term of the Lease.
- 2.3.3 Verification may be required for each employee of the Lessor, as well as employees of the Lessor's contractors or subcontractors who will provide building operating services requiring routine access to the Lessee's leased space. The Lessee may also require this information for the Lessor's employees, contractors, or subcontractors who will be engaged to perform alterations or emergency repairs in the Lessee's space.

2.4 Services

2.4.1 Janitorial Services

2.4.1.1 The Lessor shall provide a designated trash area and/or dumpster adjacent to the building of a sufficient size to accommodate an appropriate commercial-sized trash dumpster for solid waste. Lessor shall maintain a waste management contract for the life of the Lease. Individual trash cans capable of holding up to three (3) gallons and recycle cans capable of holding up to three (3) gallons shall be provided, collected, and maintained for each workstation and office by the Lessor.

2.4.1.2 The Lessor shall maintain the Premises in a clean condition and shall provide supplies and equipment for the term of the Lease, including but not limited to, all restroom and lunchroom supplies. The following schedule describes the level of services intended. The facility shall always be kept in a clean and sanitary manner; free from overflowing waste cans, fingerprints on entry doors, dirt on floors, dust, and odors. Performance will be based on the Lessee's evaluation of results, not the frequency or method of performance.

- a. Daily: Empty trash receptacles. Sweep entrances, lobbies, and corridors. Spot sweep floors, and spot vacuum carpets. Clean drinking fountains. Sweep, damp mop, or scrub restrooms. Clean all restroom fixtures, including handles of door stalls. Replenish restroom supplies. Dispose of all trash and garbage generated in or about the building. Wash inside and out or steam clean cans used for collection of food remnants from snack bars and vending machines. Dust horizontal surfaces that are readily available and visibly require dusting. Spray buff resilient floors in main corridors, entrances, and lobbies. Clean elevators and escalators. Remove carpet stains as they appear or as identified. Police sidewalks, parking areas, and driveways. Sweep loading dock areas and platforms. Clean glass entry doors to the Premises.
- b. Three (3) Times per Week: Sweep or vacuum stairs.
- c. Weekly: Spray buff all resilient floors in restrooms and health units. Sweep sidewalks, parking areas, and driveways (weather permitting). Vacuum carpet in high traffic areas.
- d. Every Two (2) Weeks: Spray buff resilient floors in secondary corridors, entrance(s), and lobbies. Damp mop and spray buff hard and resilient floors in office space.
- e. Monthly: Thoroughly dust furniture. Completely sweep and/or vacuum carpets. Sweep storage space. Spot clean all wall surfaces. Damp wipe restroom wastepaper receptacles and stall partitions.

- f. Every Two (2) Months: Damp wipe doors, windowsills, and frames. Shampoo entrance and elevator carpets.
- g. Three (3) Times per Year: Dust wall surfaces, vertical surfaces, and under surfaces. Clean metal and marble surfaces in lobbies. Wet mop or scrub garages. Vacuum carpets utilizing industrial high efficiency particulate air (HEPA) vacuums.
- h. Two (2) Times per Year: Wash all interior and exterior windows and other glass surfaces. Strip and apply four coats of finish to resilient floors in restrooms. Strip and refinish main corridors and other heavy traffic areas. Wash all venetian blinds.
- i. Annually: Wash all venetian blinds and dust six (6) months from washing. Vacuum or dust all surfaces in the Premises including light fixtures. Vacuum all draperies in place. Strip and refinish floors in offices and secondary lobbies and corridors. Shampoo carpets in corridors, lobbies, all offices and other non-public areas. Clean balconies, ledges, courts, areaways, roofs, and gutters.
- j. Every Two (2) Years: Dry clean or wash (as appropriate) all draperies.

2.4.1.3 Selection of Cleaning Products – upon request, Lessor must provide the Safety Data Sheets (SDS) for all products used. The Lessor shall make careful selection of janitorial cleaning products and equipment to use products that are packaged ecologically; use products and equipment considered environmentally beneficial and/or recycled products that are phosphate free, non-corrosive, non-flammable, and fully biodegradable; and to minimize the use of harsh chemicals and the release of irritating fumes.

2.4.2 Recycling

2.4.2.1 The Lessor shall establish and maintain a recycling program (at a minimum) for paper, corrugated cardboard, glass, plastics, and metals where local markets for recovered materials exist.

2.4.2.2 Where state or local law, code, or ordinance requires recycling programs for the Premises, Lessor shall comply with such state and local law, code, or ordinance.

2.4.2.3 When implementing any recycling program, the Lessor shall provide an easily accessible, appropriately sized area (two [2] square feet per one thousand [1,000] square feet of building gross floor area) that serves the space for the collection and storage of materials for recycling. Telecom rooms are not acceptable as recycling space. During the Lease term, the Lessor agrees, upon request, to provide the Lessee with additional information concerning recycling programs maintained in the building and in the Premises.

2.4.2.4 Lessee reserves the right to identify those recyclable materials, generated from agency operations at the Premises, which Lessee desires to sell as serviceable property. Lessee reserves the right to dispose of such materials itself. When and if the Lessee exercises this discretion, the Lessor shall thereafter not be responsible for those materials selected by the Lessee for disposal by the Lessee.

2.4.3 Landscaping

2.4.3.1 Landscaping maintenance shall be performed during the growing season (April 1 through November 1) at not less than a weekly cycle and shall consist of watering, weeding, mowing, and policing the area to keep it free of debris. Pruning and fertilization shall be done on an as-needed basis. Dead, dying, or damaged plants shall be replaced.

2.4.3.2 Landscaping management practices shall prevent pollution by employing practices that avoid or minimize the need for fertilizers and pesticides; prohibiting the use of the 2,4-Dichlorophenoxyacetic Acid (2,4-D) herbicide and organophosphates; and composting or recycling all yard waste.

2.4.3.3 If the Lessor satisfies performance of this Lease by new construction, and where conditions permit, the site shall be landscaped for low maintenance and water conservation with plants that are either native or well adapted to local growing conditions.

2.4.4 Snow and Ice Removal

2.4.4.1 Lessor shall provide snow and ice removal services for the Lessee on all days for which this Lease has designated normal hours of operation. Snow removal shall occur prior to 6:30 a.m. on business days, and anytime during weekends and holidays prior to 6:30 a.m. of the next business day. Lessor shall clear sidewalks, walkways, parking lots, and other entrances before accumulation exceeds 1.5 inches. Should accumulation continue throughout the day, the Lessor shall provide such additional snow removal services to prevent accumulation greater than the maximums specified in this paragraph. The Lessor shall keep walkways, sidewalks, and parking lots free of ice during the normal hours of operation. The Lessor shall monitor conditions following a weather event and correct all unsafe conditions that may arise due to

freezing and thawing. The Lessor shall remove excess buildup of sand and/or ice melt to minimize slipping hazards. If the building entrance(s) has a northern exposure, then Lessor shall take additional measures to protect the safety of pedestrians.

2.4.4.2 Lessor shall provide an emergency contact number for its snow removal contractor, which is available 24 hours, seven days a week, to allow Lessee to be in contact with a representative at any given time. Lessor or Lessor's contractor must respond within 1 hour after being notified by Lessee. If the Lessor or Lessor's contractor does not report at the designated time and/or forces the Lessee to remain closed due to delayed service, Lessor may be required to pay any costs incurred by Lessee to self-remedy the situation.

2.4.5 Pest Control

2.4.5.1 Control pests as appropriate, using Integrated Pest Management (IPM) techniques to the extent possible to remove and exterminate rodents, insects, and other pests. A combination of available pest control methods is to be used to manage pest damage by the most economical means, and with the least possible hazard to the people, property, and environment. A file of all inspections, corrective actions, and complaints shall be maintained by the Lessor or contractor working on behalf of the Lessor and made available upon request.

2.4.5.2 General pests and rodents shall be included within the scope of work and shall include, but not be limited to the following:

- a. General Pests: cockroaches, ants, spiders, silverfish, centipedes, millipedes, earwigs, flies, fleas, bed bugs, stored product pests, bees, wasps, hornets, and yellow jackets.
- b. Rodents: mice, rats, and chipmunks.

2.4.5.3 The contractor shall be responsible for maintaining an updated pest control logbook or file for each building or site that includes a copy of the Pest Control Plan, labels, and SDS for all pesticides used, and a copy of the Commercial Pesticide Applicator and/or Registered Technician Certificate for every representative performing on-site pest control services. The Pest Control Services Record(s) and Pest Inspection Report(s) shall be inclusive of all the information on pesticide applications required by the Pesticides Regulations at 7 Pa Code Ch. 128 as amended.

2.4.5.4 Only products permissible under federal, state, and local regulations current under the Lease Term shall be used and those only in strict accordance with precautions, directions, and recommendations shown on the label of the product. Pesticides being used shall be registered with the EPA and Pennsylvania Department of Agriculture and comply with the provisions of the Federal Insecticide, Fungicide, and Rodenticide Act of 1972 and the Pennsylvania Pesticide Control Act of 1973 and the regulations issued there under. Rodent bait stations when used must be of only of a tamper-resistant design with a sticky label that indicates the last service date.

2.5 Maintenance

The Lessor is responsible for the total maintenance and repair of the Premises. Such maintenance and repairs include the site and private access roads. All equipment and systems shall be maintained to provide reliable, energy efficient service without unusual interruption, disturbing noises, exposure to fire or safety hazards, uncomfortable drafts, excessive air velocities, or unusual emissions of dirt. The Lessor's maintenance responsibility includes initial supply and replacement of all supplies, materials, and equipment necessary for such maintenance. Lessor shall provide, install and replace all light bulbs, tubes, ballasts and starters on the Premises, which includes the parking area(s). Maintenance, testing, and inspection of appropriate equipment and systems shall be done in accordance with current applicable codes, and inspection certificates shall be displayed as appropriate.

2.5.1 Maintenance and Testing of Building Systems

2.5.1.1 Lessor shall annually test and inspect, without an additional charge to Lessee, any and all safety systems, including but not limited to fire alarm and evacuation systems, fire suppression systems, emergency generators, etc. on the Premises to ensure proper operation. Testing of systems that may cause disruption to Lessee shall occur after normal hours of operations, unless otherwise agreed upon by Lessor and Lessee. All testing and inspections shall be done in compliance with all Regulatory Requirements.

2.5.1.2 At the Lessor's expense, the Lessee reserves the right to require documentation of proper operations, inspection, testing, and maintenance of fire protection systems, such as, but not limited to, fire alarm, fire sprinkler, standpipes, fire pump, emergency lighting, illuminated exit signs, and emergency generator, prior to occupancy or at any time during the term of the Lease to ensure proper operation.

2.5.2 Fire Alarm and Evacuation System/Fire Suppression System

- 2.5.2.1 Lessor shall monitor and maintain, at Lessor's expense, a fire alarm and evacuation system and a fire suppression system compliant with the Uniform Construction Code (UCC), International Building Code (IBC), Authority Having Jurisdiction (AHJ), and in accordance with Section 3. Systems must also comply with all other Regulatory Requirements.
- 2.5.2.2 The Lessor shall maintain a dedicated voice analog/digital telephone line for the fire alarm and evacuation system.
- 2.5.2.3 Training – Lessor shall provide ongoing training, as requested by Lessee, during the term of the Lease.
- 2.5.2.4 Lessor shall, prior to any installation and/or updates to either the fire alarm and evacuation system or the fire suppression system or the security system, obtain Lessee's approval of the installation and/or update.
- 2.5.2.5 Emergency Evacuation Plan - Lessor shall cooperate, participate and comply with the development and implementation of the Lessee's Emergency Evacuation Plan, which includes the coordination of annual emergency evacuation drills.
- 2.5.3 Security System
 - 2.5.3.1 Lessor shall maintain a dedicated voice analog/digital telephone line for the security system. It will be the responsibility of the Lessor to assume the ongoing cost of monitoring and maintaining the system during the term of the Lease, as well as to respond to alarms when they occur. Lessor shall provide ongoing training, as requested by the Using Agency, throughout the life of the Lease.
 - 2.5.3.2 Lessor shall, upon request from Lessee, provide a new locking system and/or associated hardware, after a break-in or a series of thefts or other similar unusual occurrences at the Premises.
- 2.5.4 Elevators
 - 2.5.4.1 Service shall be available during the normal hours of operation. When applicable, at least one (1) elevator shall be available at all times for Lessee use. When possible, the Lessee shall be given a twenty-four-(24) hour notice if the service is to be interrupted for more than one and one-half (1-1/2) hours. Normal service interruption shall be scheduled outside of the Lessee's normal hours of operation. The Lessor shall use best efforts to minimize the frequency and duration of unscheduled interruptions.
 - 2.5.4.2 Elevator Entrapment: Lessor shall respond to an elevator entrapment within thirty (30) minutes of notification and shall promptly notify the elevator service provider of such entrapment so they can facilitate the end of the entrapment and/or repair of the elevator. If Lessor fails to acknowledge the notification and take prompt action within said time, Lessee shall have the option to charge Lessor a penalty of two hundred and fifty dollars (\$250).
- 2.5.5 Heating, Ventilation, Air Conditioning (HVAC)
 - 2.5.5.1 Lessor is responsible for maintenance of all HVAC equipment, and shall follow the American National Standards Institute (ANSI)/American Society of Heating, Refrigerating and Air-Conditioning Engineers (ASHRAE)/Air Conditioning Contractors of America (ACCA) Standard 180, Standard Practice for Inspection and Maintenance of Commercial Building HVAC Systems.
 - 2.5.5.2 During normal hours of operation in periods of heating and cooling, ventilation shall be provided in accordance with the PA Uniform Construction Code (PAUCC), International Mechanical Code, International Energy Conservation Code, and with current ASHRAE Standards 90.1 and ASHRAE Standard 62.1.
 - 2.5.5.3 Temperature Controls: HVAC systems shall maintain the occupied temperature and humidity setpoints of 75 degrees Fahrenheit (°F) cooling, 67°F heating, and relative humidity between 30–60 percent (30%–60%) during all seasons; the unoccupied temperature setpoints shall be maintained at 85°F cooling and 60°F heating. The occupied temperature and relative humidity setpoints shall be maintained thirty (30) minutes prior to opening for normal hours of operation.
 - 2.5.5.4 Air filtration shall be provided and maintained with filters having a minimum efficiency rating as determined by the latest edition of ASHRAE Standard 52.2, Method of Testing General Ventilation Air Cleaning Devices for Removal Efficiency by Particle Size. Pre-filters shall have a MERV efficiency of 8. Final filters shall have a MERV efficiency of 11.
- 2.5.6 Maintenance of Provided Finishes
 - 2.5.6.1 Paint, Wall Coverings: Lessor shall maintain all wall coverings and high-performance paint coatings in "like new" condition for the life of the Lease. All painted surfaces shall be repainted at the Lessor's expense any

time during the occupancy by the Lessee if the paint is peeling or permanently stained, except where damaged due to the negligence of the Lessee. All work shall be done after normal hours of operation as defined in this Lease. In addition, Lessor shall comply with the following requirements:

- a. Lessor shall repaint Amenity Areas at least every three (3) years.
- b. Lessor shall perform cyclical repainting, at Lessee's request, of the Premises every five (5) years of occupancy. This cost, including the moving and returning of furnishings, as well as disassembly and reassembly of systems furniture per manufacturer's warranty, shall be at the Lessor's expense.

2.5.6.2 Carpet and Flooring: Except when damaged by the Lessee, the Lessor shall repair or replace flooring at any time during the Lease term when: (a) backing or underlayment is exposed; (b) there are noticeable variations in surface color or texture; (c) It has curls, upturned edges, or other noticeable variations in texture; (d) tiles are loose; or, (e) tears or tripping hazards are present. All work shall be done after normal hours of operation as defined in this Lease.

- a. Notwithstanding the foregoing, the Lessor shall replace all carpet in the Premises, at Lessee's request, every ten (10) years with a product that meets the requirements of Section 3 of this Lease. Repair or replacement shall include the moving and returning of furnishings, including disassembly and reassembly of systems furniture per manufacturer's warranty, if necessary.

2.5.7 Parking Areas

2.5.7.1 Lessor shall be responsible, throughout the term of the Lease, for the maintenance and repair, including but not limited to, parking lot, area, or garage lighting, the black top of the parking lot, area, or garage and the repainting of parking lines every five (5) years or sooner if necessary and agreed upon by Lessee and Lessor. Lessor shall respond within ten (10) business days of notification by Lessee of holes and/or cracks, which pose a safety hazard, in the parking lot, area or garage.

2.5.8 Building Signage

2.5.8.1 Lessor is responsible to maintain building signage. In the event signage needs to be repaired or replaced, the Lessor must coordinate with the Using Agency to ensure compliance with the most current Governor's Office branding specifications. Lessor shall be responsible for the payment of any signage fees imposed by local governmental authorities.

2.5.9 Roof Maintenance

2.5.9.1 Lessor shall monitor the conditions of the roof, gutters, and awnings and clean, repair, and maintain, as needed, and to prevent safety hazards from occurring due to the weight of snow on the roof or the melting and thawing of ice that could result in icicles forming. Gutters should be clear of all debris, snow, and ice to allow for proper drainage.

2.5.9.2 The Lessor shall promptly investigate and eliminate roof leaks. Repairs must be completed in a safe and expeditious manner. The responsibility for the remedies shall be solely at the Lessor's expense, including but not limited to, air quality testing and remediation, if necessary.

2.5.10 Indoor Air Quality

2.5.10.1 The Lessor shall make a reasonable attempt to apply insecticides, paints, glues, adhesives, and HVAC system cleaning compounds with highly volatile or irritating organic compounds, outside of working hours. Except in an emergency, the Lessor shall provide at least a seventy-two- (72) hour notice to the Lessee before applying noxious chemicals in the Premises and shall adequately ventilate the Premises during and after application. and provide odor and dust free containments from occupied area and isolate the HVAC system.

2.5.10.2 The Lessor shall provide to the Lessee Safety Data Sheets (SDS) upon request for the following products prior to their use during the term of the Lease: adhesives, caulking, sealants, insulating materials, fireproofing or fire stopping materials, paints, carpets, floor and wall patching or leveling materials, lubricants, clear finish for wood surfaces, janitorial cleaning products, pesticides, rodenticides, and herbicides. The Lessee reserves the right to review such products used by the Lessor within the Premises, including Amenity Areas, ventilation systems and zones serving the Premises, and the area above suspended ceilings and engineering space in the same ventilation zone as the Premises. The Lessee may eliminate from consideration products with significant quantities of toxic, flammable, corrosive, or carcinogenic material, and products with potential for harmful chemical emissions. Materials used often or in large quantities will receive the greatest amount of review.

- 2.5.10.3 The Premises shall be free from mold growth and free from any conditions that reasonably can be anticipated to permit the growth of mold or are indicative of the possibility that mold will be present.
- 2.5.10.4 The Lessor shall promptly investigate indoor air quality (IAQ) complaints and shall implement the necessary controls to address the complaint. In the event that IAQ complaints continue for more than two (2) weeks, the Lessor will be responsible for the cost of hiring a ventilation/IAQ engineer or a certified industrial hygienist to evaluate the cause(s) of the complaints.
- 2.5.10.5 In any event of, including but not limited to, a flood, water damage not caused by Lessee, or repairs caused by the Lessor, the Lessor shall, at its sole cost, expense, and risk (a) cause a certified industrial hygienist or qualified consultant (“the Inspector”) who, in either instance, is reasonably acceptable to Lessee, to inspect and evaluate the Premises for the presence of mold indicators; and (b) cause the Inspector to deliver the results of its inspection and evaluation (“the Report”) within fifteen (15) days after the inspection. The Lessor shall provide the report to Lessee immediately upon receipt. If the report indicates that mold indicators are present in the Premises, the Lessor, at its sole cost, expense, and risk, shall, within fifteen (15) days after receipt of the Report, retain an experienced mold remediation contractor reasonably acceptable to Lessee to remediate the mold or the indicators in the Premises. Prior to commencing such remediation, Lessor shall notify Lessee of (a) the date on which the remediation shall begin and anticipated length of time it is projected to continue; (b) which portion of the Premises shall be subject to remediation; and (c) the remediation procedures and standards to be used and the clearance criteria to be employed at the conclusion of the remediation.
- 2.5.10.6 The Lessee reserves the right to conduct independent IAQ assessments and detailed studies in the Premises as well as in spaces serving the Premises (e.g., Amenity Areas, mechanical rooms, HVAC systems, etc.). The Lessor shall assist the Lessee in its assessments and detailed studies by making available information on building operations and Lessor activities; providing access to the Premises for assessment and testing, if required; and implementing corrective measures, if any, required by the Lessee.
- 2.5.10.7 The Premises shall be free of hazardous materials, including hazardous substances and hazardous wastes, as defined by and according to applicable Regulatory Requirements, prior to commencement of the Lease, and at all times during the life of the Lease. Should there be reason to suspect otherwise, Lessee reserves the right, at Lessor’s expense, to require documentation or testing to confirm that the Premises is free of all hazardous materials. Lessor shall, to the extent of its knowledge, notify Lessee of the introduction of any hazardous materials onto the Premises by Lessor or others, including but not limited to, co-tenants occupying space in the building.
- 2.5.10.8 Radon – The Lessor is responsible to provide Premises in which radon levels are within acceptable levels in accordance with the US Environmental Protection Agency (EPA). In the event radon is detected at or above the EPA recommended action levels, the Lessor shall promptly take all necessary action to bring the Premises within EPA recommended action levels. If Lessor fails to exercise due diligence or is otherwise unable to reduce the radon concentration promptly to below the EPA recommended action levels, Lessee may implement a corrective action program and deduct its costs from the Rent.

APPENDIX D

STANDARD BUILDING CONSTRUCTION SPECIFICATIONS

(Section 3 of the Lease)

AND

AGENCY SPACE REQUIREMENTS

(Section 4 of the Lease)

(Note: these specifications are primarily intended for new construction, however, proposals submitted to retrofit an existing building utilizing existing building systems and walls as long as the requirements are met.

3 STANDARD BUILDING CONSTRUCTION SPECIFICATIONS

Information in this section pertains to items related to the construction and/or substantial rehabilitation of the building structure and its systems. These specifications are the minimum standards required unless otherwise specified on the Lease Cover Sheet or in Section 4.

3.1 General Requirements

- 3.1.1 The Lessor shall be responsible for the professional quality, technical accuracy, and the coordination of all designs, drawings, specifications, and other services furnished by the Lessor under this Lease. The Lessor shall, without additional compensation, correct or revise any errors or deficiencies in its designs, drawings, specifications, or other services.
- 3.1.2 The Lessor shall be solely responsible for designing, constructing, operating, and maintaining the leased premises in full accordance with the requirements of the Lease. The Lessee retains the right to review and approve the Lessor's design, including without limitation, review of the Lessor's design and construction drawings, shop drawings, product data, finish samples, and completed base building and Tenant Improvement (TI) construction. Such review and approval is intended to identify potential design flaws, to minimize costly misdirection of effort, and to assist the Lessor in its effort to monitor whether such design and construction comply with applicable Regulatory Requirements and satisfy all Lease requirements.
- 3.1.3 The Lessor shall provide all information required whether it is found in this Lease, special requirements and attachments, price lists, or design intent drawings, to space planners, architects, engineers, construction contractors, and any applicable documents required to fulfill this Lease. Reliance upon one of these documents to the exclusion of any other may result in an incomplete understanding of the scope of the work to be performed and/or services to be provided.
- 3.1.4 Labor Standards - Lessor agrees to satisfy the requirements of this Lease through the construction of a new building, the complete rehabilitation or reconstruction of an existing building, or the retrofit of existing building systems and walls as long as the requirements of the Lessee are met.
- 3.1.5 Work Performance - Lessor shall ensure all work in performance of this Lease shall be done by skilled workers or mechanics. Lessor shall:
 - a. Construct and renovate the Premises, at Lessor's sole cost and expense, and in return for Rent paid by Lessee, in accordance with all plans and specifications set herein, and within the timeframe set forth on the Lease Cover Sheet;
 - b. Not begin any construction or renovation until after the Lease has been executed and a pre-construction meeting has been held with all appropriate parties to include the Lessor and Lessor's contractors, DGS/BRE and the Using Agency;
 - c. Comply with all applicable Regulatory Requirements, applying whichever is most stringent. All work shall conform to the latest standards of the trade;
 - d. Furnish all labor, superintendence, materials, tools, and equipment, and perform all work necessary to complete all construction to the satisfaction of the Lessee; and
 - e. Shall restore the area in such a manner that is acceptable to Lessee.
- 3.1.6 If the new construction, substantial rehabilitation, or renovation of an existing building costs more than fifty percent (50%) of the replacement cost of the building, it shall be designed and constructed as a high-performance building achieving a ten percent (10%) reduction in energy consumption over ANSI/ASHRAE/IES Standard 90.1.2016.
- 3.1.7 Recycled Content Products - whenever feasible, the Lessor shall use recycled content products as designated by the EPA.
- 3.1.8 Environmentally Preferable Building Products and Materials - whenever feasible, the Lessor shall use environmentally preferable products and materials. The Lessor is encouraged to consider the lifecycle analysis of the product in addition to the initial cost and is encouraged to use products that are extracted and manufactured regionally.
- 3.1.9 Existing Fit-Out, Salvaged, or Reused Building Material - items and materials existing in the Premises, or to be removed from the Premises during the demolition phase, are eligible for reuse in the construction phase of the project. The reuse of items and materials is preferable to recycling them; however, items considered for reuse shall be in re-furbished condition and shall meet the quality standards set forth in this Lease. In the absence of definitive quality standards, the Lessor is responsible to confirm that the quality of the item(s) in question shall meet or exceed accepted industry or trade standards for first-quality commercial-grade applications.

- 3.1.10 Construction Waste Management - the recycling of construction waste is preferable and must comply with all Regulatory Requirements. If any waste materials encountered during the demolition or construction phase are found to contain lead, asbestos, polychlorinated biphenyls (PCBs), such as fluorescent lamp ballasts, or other harmful substances, they shall be handled and removed in accordance with Regulatory Requirements concerning hazardous waste.
- 3.1.11 Floors and Floor Load – under-floor surfaces shall be smooth and level. All floor areas shall be designed in accordance with the PA Uniform Construction Code (PAUCC).
- 3.1.12 Mechanical, Electrical, Plumbing (General) - Lessor shall provide and operate all building equipment and systems in accordance with applicable technical publications, manuals, PAUCC, and standard procedures. Mains, lines, and meters for utilities shall be provided and maintained by the Lessor. Exposed ducts, piping, and conduits are not permitted in the Premises.
- 3.1.13 Asbestos –Prior to the Commencement Date, the Lessor is responsible for having an asbestos survey completed relative to the entire building in which the Premises is located. The building must be inspected by PA L&I-certified inspector(s), each with a minimum of one-year experience in conducting building inspections for asbestos-containing materials (ACM). Upon request, Lessor must provide Lessee with a copy of the asbestos certification inspection report. This paragraph does not apply to new construction.
- 3.1.14 Janitor Closets
 - 3.1.14.1 Janitor closets with service sink, hot and cold water, and ample storage for cleaning equipment, materials, and supplies shall be provided on all floors. Each janitor closet door shall be fitted with an automatic lock.
 - 3.1.14.2 When not addressed by local code, Lessor shall provide containment drains plumbed for appropriate disposal of liquid wastes in spaces where water and chemical concentrate mixing occurs for maintenance purposes. Disposal is not permitted in restrooms.

3.2 General Design and Construction Requirements

3.2.1 Indoor Air Quality During Construction

Lessor must comply with the following requirements when renovations occur while any portion of the Premises is occupied by Lessee:

- 3.2.1.1 The Lessor shall sequence the installation of finish materials so that materials that are high emitters of volatile organic compounds (VOCs) are installed and allowed to cure before installing interior finish materials, especially soft materials that are woven, fibrous, or porous in nature, which may adsorb contaminants and release them over time.
- 3.2.1.2 Where demolition or construction work occurs in the leased space or adjacent to the Premises, the Lessor shall erect appropriate barriers (noise, dust, odor, etc.) and take necessary steps to minimize interference with the occupants. This includes maintaining acceptable temperature, humidity, and ventilation in the occupied areas during window removal, window replacement, or similar types of work.
- 3.2.1.3 HVAC During Construction: If air handlers are used during construction, the Lessor shall provide filtration media with a minimum efficiency reporting value (MERV) of 8 at each return air grill, as determined by the latest edition of American Society of Heating, Refrigerating and Air-Conditioning Engineers (ASHRAE) Standard 52.2, *Method of Testing General Ventilation Air Cleaning Devices for Removal Efficiency by Particle Size*. The permanent HVAC system may be used to move both supply and return air during the construction process only if the following conditions are met:
 - a. A complete air filtration system with 60 percent (60%) efficiency filters is installed and properly maintained.
 - b. No permanent diffusers are used.
 - c. No plenum type return air system is employed.
 - d. The HVAC duct system is adequately sealed and isolated from the occupied area to prevent the spread of airborne particulate and other contaminants.
 - e. Following the building “flush out,” all duct systems are vacuumed with portable high-efficiency particulate arrestance (HEPA) vacuums and documented clean in accordance with National Air Duct Cleaners Association (NADCA) specifications.

3.2.1.4 Flush-Out Procedure:

- a. A final flush-out period of seventy-two (72) hours minimum is required after installation of all interior finishes and before occupancy of the space. The Lessor shall ventilate twenty-four (24) hours a day, with new filtration media at 100 percent (100%) outdoor air (or maximum outdoor air while achieving a relative humidity not greater than 60 percent (60%).
- b. After the three (3) day period the Premises may be occupied; however, the flush out must continue for thirty (30) days using the maximum percentage of outdoor air consistent with achieving thermal comfort and humidity control.
- c. Any deviation from this ventilation plan must be approved by the Lessee.
- d. The Lessor is required to provide regularly occupied areas of the Premises with new air filtration media before occupancy that provides a MERV of 13 or better.
- e. During construction, meet or exceed the recommended design approaches of the Sheet Metal and Air Conditioning National Contractors Association (SMACNA) *IAQ Guideline for Occupied Buildings Under Construction*, 1995, Chapter 3.
- f. Protect stored onsite and installed absorptive materials from moisture damage.

3.2.2 Lessor Design/Construction Milestones

Design and construction activities for the Premises shall commence upon Lease Execution. The Lessor shall include the following activities to achieve timely completion of the work required by this Lease:

- a. Develop preliminary floor plan and test fit for review by the Using Agency.
- b. Preliminary Design Site visit with Using Agency to verify design and existing conditions.
- c. Coordinate furniture plan, voice/data, and security/access control system with architectural plans prior to final design.
- d. Coordinate design review meetings, as needed.
- e. Prepare final architectural drawings/construction documents.
- f. Provide final architectural floor plan to Using Agency for final review and approval.
- g. Coordinate design review meetings as needed.
- h. Submit final architectural drawings for permit application process.
- i. Provide shop drawings/submittals to Using Agency for review.
- j. Prepare construction schedule identifying the critical construction progress milestones for each discipline.
- k. Coordinate pre-construction meeting with Lessee.
- l. Execute all phases of construction activities with all trades and/or vendors.
- m. Coordinate substantial completion inspection (punch list) with Lessee, architect, and contractors (thirty [30] days prior to acceptance inspection).
- n. Obtain Certificate of Occupancy.
- o. Coordinate final acceptance inspection with Lessee for Lease commencement (thirty [30] days after substantial completion inspection).
- p. Complete any remaining punch list items within thirty (30) days of acceptance inspection.

3.2.3 Construction Documents

The Lessor's Construction Documents (CDs) shall include all mechanical, electrical, plumbing, fire protection, life safety, lighting, structural, security, and architectural improvements scheduled for inclusion into the Premises. The CDs shall be annotated with all applicable specifications. The CDs shall also clearly identify Tenant Improvements (TIs) already in place and the work to be done by the Lessor or others. Notwithstanding the Lessee's review of the CDs, the Lessor is solely responsible and liable for their technical accuracy and compliance with all applicable Lease requirements. The Lessor shall provide Computer Aided Design (CAD) drawings in DWG format of the architectural layout of the space to the Lessee upon request so that furniture layouts can be conducted.

3.2.4 Construction Schedule and Pre-Construction Meeting

The Lessor shall furnish a detailed construction schedule (such as Critical Path Method) identifying the sequence of construction and critical milestones for all disciplines to be presented at the Pre-Construction Meeting. Such schedule shall also indicate the dates available for Lessee's contractors to install furniture, telephone/data lines, and/or equipment, as required. The Lessor will have contractor representatives including its architects, engineers, general contractor, and sub-contractor representatives in attendance at the Pre-Construction Meeting. The Lessor shall keep meeting minutes of discussion topics and attendance and distribute to all parties.

3.2.5 Submittals

The Lessor shall furnish submittals and/or shop drawings to the Using Agency for review and comment to coordinate with the CDs and Lease Specifications. Submittals include but are not limited to the following:

- a. Room Finish Schedule to coordinate suite/room numbers for signage and mailing addresses;
- b. Door Schedule with hardware sets to coordinate operating functions with space requirements, keying/locking requirements, security, and access control;
- c. Light fixture schedule to coordinate with space requirements.

3.2.6 Progress Reports

After start of construction, the Lessor shall submit to the Using Agency bi-weekly written progress reports. Each report shall include information as to the percentage of the work completed by phase and trade; a statement as to expected completion and occupancy dates; changes introduced into the work; and general remarks on such items as material shortages, strikes, weather, etc., that may affect timely completion. In addition, at the Lessee's discretion, the Lessor shall conduct meetings every two (2) weeks to brief Lessee's representative and/or contractors regarding the progress of design and construction of the Premises. The Lessor shall be responsible for taking and distributing minutes of these meetings.

3.2.7 Access by the Lessee Prior to Acceptance

The Lessee shall have the right to access any space within the Premises during construction for the purposes of performing inspections or installing Lessee furnished equipment. The Lessee shall coordinate the activity of Lessee's contractors with the Lessor to minimize conflicts with and disruption to other contractors on site. Access shall not be unreasonably denied to authorized Lessee officials including, but not limited to, Lessee contractors, subcontractors, or consultants acting on behalf of the Lessee on this project.

3.2.8 Construction Inspections

The Lessee or the Lessee's designated technical representative may periodically inspect construction work to review compliance with Lease requirements and approved CDs. Periodic reviews, witnessing of tests and inspections by the Lessee shall not constitute approval of the Lessor's apparent progress toward meeting the Lessee's objectives but are intended to discover any information which the Lessee may be able to call to the Lessor's attention to prevent costly misdirection of effort. The Lessor shall remain responsible for designing, constructing, operating, and maintaining the Premises in full accordance with the requirements of the Lease.

3.2.9 Acceptance of Space and Certificate of Occupancy

3.2.9.1 Ten (10) working days prior to the completion of the Premises, the Lessor shall schedule the inspection of the Premises for acceptance with Lessee. The Lessee shall accept the Premises only if the construction of the building shell, TIs, and a Certificate of Occupancy ("C of O") has been issued.

3.2.9.2 The Premises shall be considered substantially complete only if it may be used for its intended purpose, and completion of remaining work will not interfere unreasonably with the Lessee's enjoyment of the Premises.

3.2.10 As-Built Drawings

Not later than thirty (30) days after the acceptance of the Premises, the Lessor, at Lessor's expense, shall furnish to the Lessee a complete set of CAD files of as-built floor plans showing the space under Lease, as well as corridors, stairways, and core areas. The plans shall have been generated by a CAD program that is compatible with the latest release of AutoCAD or earlier release as requested by the lessee. The As-Built Drawings must be provided in both DWG and PDF formats. Clean and purged files shall be submitted electronically. They shall be labeled with building name, address, list of drawing(s), date of the drawing(s), and Lessor's architect and architect's phone number.

3.3 Construction Specifications

3.3.1 Division 02—Existing Conditions

The Lessor shall remove existing abandoned electric, telephone, and data cabling and devices, as well as any other improvements or fixtures in place to accommodate the Lessee's requirements. Any demolition of existing improvements that is necessary to satisfy the Lessee's layout shall be done at the Lessor's expense.

3.3.2 Division 06—Wood, Plastics, and Composites

3.3.2.1 Cabinets, Counters, Shelves: Cabinets shall meet the ANSI and the Kitchen Cabinet Makers Associations (KCMA) A161.1 certification requirements and be constructed from solid hardwood materials. The manufacturer shall be certified as part of the KCMA Environmental Stewardship Program (ESP).

3.3.3 Division 07—Thermal and Moisture Protection

3.3.3.1 Adhesives and Sealants: All adhesives employed on this project (including, but not limited to, adhesives for carpet, carpet tile, plastic laminate, wall coverings, adhesives for wood, or sealants) shall be those with the lowest possible VOC content below twenty (20) grams per liter and which meet the requirements of the manufacturer of the products adhered or involved. The Lessor shall use adhesives and sealants with no formaldehyde or heavy metals. Adhesives and other materials used for the installation of carpets shall be limited to those having a flash point of 140 degrees Fahrenheit or higher. The SDS must be maintained on site and available upon request for all products being utilized.

3.3.4 Division 08—Openings

3.3.4.1 Windows—Glass, Glazing, Window Lights, Frame

The Premises shall have windows in each exterior bay unless waived by the Lessee. All windows shall be weather tight, preferably inoperable. Operable windows that open shall be equipped with a sturdy locking device. Windows accessing fire escapes must be readily operable from the inside of the building.

3.3.4.2 Doors—Frames, Hardware, Locks

3.3.4.2.1 Exterior and Amenity Area Doors and Hardware

Exterior building doors and doors necessary to the lobbies, Amenity Areas, and core areas shall be required. This does not include suite entry or interior doors specific to TIs.

Exterior doors shall be weather tight and shall open outward in the direction of egress. Hinges, pivots, and pins shall be installed in a manner that prevents removal when the door is closed and locked. These doors shall have a minimum clear opening of 32 inches clear wide by 80 inches high (per leaf). Doors shall be heavy-duty, flush, and (a) hollow steel construction, (b) solid core wood, or (c) insulated tempered glass. As a minimum requirement, hollow steel doors shall be fully insulated, flush, and 16-gauge hollow steel. Solid core wood doors and hollow steel doors shall be at least 1-3/4 inches thick. Door assemblies shall be of durable finish and shall have an aesthetically pleasing appearance acceptable to the Lessee. The opening dimensions and operations shall conform to the governing building fire safety, accessibility, and energy codes and/or requirements. Fire door assemblies shall be listed and labeled. Labels on fire door assemblies shall be maintained in a legible condition. Fire door assemblies and their accompanying hardware, including frames and closing devices shall be installed in accordance with the requirements of NFPA 80: *Standard for Fire Doors and Other Opening Protectives*.

Exterior doors and all Amenity Area doors shall have door handles or door pulls with heavyweight hinges. All doors shall have corresponding doorstops (wall or floor mounted) and silencers. All public use doors and restroom doors shall be equipped with kick plates. All doors shall have automatic door closers. All building exterior doors shall have locking devices installed to prevent unauthorized entry.

3.3.4.2.2 Doors—Entrance and Vestibule Doors

Entrance doors must be provided as shown on drawings. They must swing in the direction of egress and be constructed of metal and glass to conform to PAUCC requirements (current as of the Lease Execution Date). Doors shall have a minimum clear opening of 36 inches wide and must be equipped with kick plates, push-pull plates, and automatic door closers. Doorframes must be of the same metal to match the doors. Finished surface must be primed and finished with a low VOC semi-gloss, oil-based paint finish with no formaldehyde.

Interior vestibule doors must be provided in all public and staff entrances, and vestibule doors must match exterior doors and be equipped with kick plates, push-pull plates, and automatic door closing devices. All exit doors must swing outward. Framework must be metal constructed and must match exterior doors.

3.3.4.2.3 Door—Suite Entry

Entrance doors must swing outward and be constructed of metal and glass to conform with PAUCC requirements. Doors shall have a minimum clear opening of 36 inches wide and must be equipped with kick plates, push-pull plates, and automatic door closers. Doorframes must be of the same metal to match the doors. Finished surface must be primed and finished with a low VOC semi-gloss, oil-based paint finish with no formaldehyde.

Interior vestibule doors must be provided in all public entrances and in staff entrances when appropriate. Vestibule doors shall match exterior doors and be equipped with kick plates, push-pull plates, and automatic door closing devices. All exit doors must swing in the direction of egress. Framework must be metal constructed and must match exterior doors.

3.3.4.2.4 Doors—Hardware

Doors shall have door handles or door pulls with heavyweight hinges. The Lessor is encouraged to avoid the use of chrome-plated hardware. All doors shall have corresponding doorstops (wall- or floor-mounted) and silencers. Hardware must be of one design and finish. All entrance and exit doors must be keyed alike. A delayed action door closer shall be installed at the accessible entrance, which should be tested annually and adjusted, as needed. All door operations and hardware must meet the Americans with Disabilities Act (ADA) standards.

3.3.4.2.5 Doors—Locks

Door locks are required on all interior doors. All doors must remain on the Building Master Key System. Doors designated by the Lessee shall be equipped with 5-pin, tumbler cylinder locks and strike plates. All locks shall be master keyed. A sufficient number of master keys for each lock must be provided to the Lessee. Any exterior entrance shall have a high security lock, with appropriate key control requirements contained in Section 4. Hinge pins and hasps shall be secured against unauthorized removal by using spot welds or pinned mounting bolts. The exterior side of the door shall have a lock guard or astragal to prevent tampering of the latch hardware. Doors used for egress only shall not have any operable exterior hardware.

3.3.5 Division 09—Finishes

3.3.5.1 Wall Construction and Finishes

3.3.5.1.1 Partitions - General

Partitions in public areas shall be marble, granite, hardwood, or drywall covered with durable wall covering or high-performance coating, or equivalent pre-approved by the Lessee. Partitioning requirements may be satisfied with existing partitions if they meet the Lessee's standards and layout requirements and are suitable for the designed use of the space.

The HVAC system shall be rebalanced, and lighting repositioned, as appropriate, after installation of partitions.

If installed in accordance with the Automatic Fire Sprinkler System and Fire Alarm System paragraphs, sprinklers and fire alarm notification appliances shall be repositioned as appropriate after installation of partitions to maintain the level of fire protection and life safety.

3.3.5.1.2 Partitions – Permanent

Permanent partitions shall extend from the structural floor slab to the structural ceiling slab. They shall be provided by the Lessor as necessary to surround the Premises, stairs, corridors, elevator shafts, restrooms, all columns, and janitor closets. They shall have a flame spread rating of 25 or less and a smoke development rating of 450 or less (ASTM E84-18 (or latest version at time of lease execution), *Standard Test Method for Surface Burning Characteristics of Building Materials*). Stairs, elevators, and other floor openings shall be enclosed by partitions and shall have the fire resistance required by the applicable building code, fire code, and ordinances adopted by the jurisdiction (such as the International Building Code, etc.) in which the building is located current as of the Lease Execution Date.

3.3.5.1.3 Partitions – Subdividing

Office subdividing partitions shall comply with applicable building codes and Regulatory Requirements and shall be provided as part of the TIs. Partitioning shall extend from the finished floor to the finished ceiling and shall be designed to provide a minimum sound transmission class (STC) of 37. Partitioning shall be installed by the Lessor at locations to be determined by the Lessee as identified in the CDs. They shall have a flame spread rating of 25 or less and a smoke development rating of 450 or less (ASTM E84-18 (or latest version at time of lease execution)), *Standard Test Methods for Surface Burning Characteristics of Building Materials*).

3.3.5.2 Wall Furring

Unless agreed upon otherwise, all interior brick, tile, or concrete block walls are to be furred out with metal, wood, or other materials acceptable and approved by Lessee, constructed from floor to ceiling height and insulated. The furring must be of suitable type and size to support the weight of the interior finishing.

3.3.5.3 Insulation—Thermal, Acoustic, and HVAC

All insulation products shall contain recovered materials as required by EPA's Comprehensive Procurement Guideline (CPG) and related recycled content recommendations. No insulation installed with this project shall be material manufactured using chlorofluorocarbons (CFCs), nor shall CFCs be used in the installation of the product. All insulation containing fibrous materials exposed to airflow shall be rated for that exposure or shall be encapsulated. Insulating properties for all materials shall meet or exceed applicable industry standards. Polystyrene products shall meet ASTM C578-18 (or latest version at time of lease execution) *Standard Specification for Rigid, Cellular Polystyrene Thermal Insulation*. All insulation shall be low emitting with not greater than .05 parts per million (ppm) formaldehyde emissions. The maximum flame spread, and smoke developed index for insulation shall meet the requirements of the applicable Regulatory Requirements (current as of the Lease Execution Date) adopted by the jurisdiction in which the building is located.

3.3.5.4 Wall Finishes—Shell

Prior to occupancy, all restrooms within the building Amenity Areas of Lessee-occupied floors shall have (a) ceramic tile, recycled glass tile, or comparable wainscot from the finished floor to a minimum height of 4 feet 6 inches; and (b) semi-gloss paint on remaining wall areas or other finish approved by the Lessee. All elevator areas that access the Premises and hallways accessing the Premises shall be covered with wall coverings not less than 20 ounces per square yard, high performance paint, or an equivalent.

3.3.5.5 Painting

The Lessor shall bear the expense for all painting associated with the building shell. These areas shall include all Amenity Areas. Exterior perimeter walls and interior core walls within the Premises shall be spackled and prime painted with low VOC primer. If any building shell areas are already painted prior to TIs, then the Lessor shall repaint, at the Lessor's expense, as necessary during TIs.

Prior to acceptance, all surfaces within the Premises, which are designated by Lessee for painting, shall be newly finished in colors acceptable to the Using Agency. The Lessor shall provide interior paints and coatings that meet or are equivalent to the following standards for VOC off gassing:

- a. Architectural paints, coatings, and primers applied to interior walls and ceilings: (a) flats—50 grams per liter (g/L), (b) non-flats—150 g/L.
- b. Anti-corrosive and anti-rust paints applied to interior ferrous metal substrates: 250 g/L
- c. Clear wood finishes: (a) varnish—350 g/L, (b) lacquer—550 g/L
- d. Floor coatings: 100 g/L
- e. Sealers: (a) waterproofing sealers—250 g/L; (b) sanding sealers—275 g/L; (c) all other sealers—200 g/L
- f. Shellacs: (a) clear—730 g/L; (b) pigmented—550 g/L
- g. Stains: 250 g/L

3.3.5.6 Ceilings

A complete acoustical ceiling system (which includes grid and lay-in tiles or other building standard ceiling system as approved by the Lessee) throughout the Premises shall be required. The acoustical ceiling system shall be furnished, installed, and coordinated with TIs.

Ceilings shall be at a minimum 9 feet 0 inches and no more than 12 feet 0 inches measured from floor to the lowest obstruction. Areas with raised flooring shall maintain these ceiling-height limitations above the finished raised flooring. Bulkheads and hanging or surface mounted light fixtures which impede traffic ways shall be avoided. Ceilings shall be uniform in color and appearance throughout the Premises with no obvious damage to tiles or grid.

Prior to closing the ceiling, the Lessor shall coordinate with the Lessee for the installation of any items above the ceiling.

Ceilings shall be a flat plane in each room and shall be suspended and finished as follows unless an alternate equivalent is pre-approved by the Lessee:

- a. Restrooms: Plastered or spackled and taped gypsum board.
- b. Offices and Conference Rooms: Mineral and acoustical tile or lay-in panels with textured or patterned surface and regular edges or an equivalent pre-approved by the Lessee. Tiles or panels shall contain a minimum of 30 percent (30%) recycled content.
- c. Corridors and eating/galley areas: Plastered or spackled and taped gypsum board or mineral acoustical tile.

3.3.5.7 Acoustical Requirements

Reverberation Control: Private office and conference rooms using suspended acoustical ceilings shall have a noise reduction coefficient (NRC) of not less than 0.65 in accordance with ASTM C423-17 (or latest version at time of lease execution) *Standard Test Method for Sound Absorption and Sound Absorption Coefficients by the Reverberation Room Method*. Open offices using suspended acoustical ceilings shall have an NRC of not less than 0.75. Private offices, conference rooms, and open offices using acoustical cloud or acoustical wall panels with a minimum of 70 percent (70%) coverage shall have an NRC of not less than 0.85.

Ambient Noise Control: Ambient noise from mechanical equipment shall not exceed noise criteria curve (NC) 35 in accordance with the ASHRAE *Handbook of Fundamentals* for offices and conference rooms; NC 40 in corridors, cafeterias, lobbies, and restrooms; NC 50 in other spaces.

Noise Isolation: Rooms separated from adjacent spaces by ceiling-high partitions (not including doors) shall not be less than the following noise isolation class (NIC) standards when tested in accordance with ASTM E336-71 (or latest version at time of lease execution), *Standard Test Method for Measurement of Airborne Sound Attenuation between Rooms in Buildings*, (a) conference rooms—NIC 40 and (b) offices—NIC 35.

Testing: The Lessee may require, at Lessor's expense, test reports by a qualified acoustical consultant showing that acoustical requirements have been met.

3.3.5.8 Flooring

Exposed interior floors in primary entrances and lobbies shall be marble, granite, terrazzo, or other similar solid-surface, high-performance material. Exposed interior floors in secondary entrances, elevator lobbies, and primary interior corridors shall be high-grade carpet, marble, granite, terrazzo, or other similar high-performance material. Resilient flooring shall be used in telecommunications rooms. Floor perimeters at partitions shall have wood, rubber, vinyl, marble, or carpet base. Terrazzo, unglazed ceramic tile, recycled glass tile, and/or quarry tile shall be used in all restroom and service areas of Lessee-occupied floors. Carpet tile shall be used in all office space unless otherwise scheduled. Any alternate flooring must be pre-approved by the Lessee.

3.3.6 Divisions 10, 11, and 12—Specialties, Equipment, and Furnishings
(Items contained in this Section 3.3.6 are specialty items to be identified as an Agency Requirement in Section 4 of this Lease).

3.3.6.1 Operable Panel Partitions (Folding Partitions)

Accordion folding partitions shall be provided to divide rooms into smaller spaces as identified in Section 4. Work for these partitions shall include the furnishing of all materials, equipment, and labor necessary for the complete installation of all accordion folding partitions specified in Section 4. Include all accessories and parts necessary to complete this work by an experienced installer, in a professional manner, and in accordance with the manufacturer's installation instructions and warranty requirements. The work includes, but is not limited to, the following: (a) accordion folding partition operated manually and related partition header; (b) paired units required for 10 feet or larger openings with equal stacking; and (c) Soundmaster, Model 8M as manufactured by Modernfold or another manufacturer approved by the Lessee as equal. In rooms containing the accordion partitions, commercial grade exhaust fan(s) vented to the exterior shall be installed in such a manner that when the partitions are closed, there is an exhaust fan in each newly created area. Fans to be controlled by on/off switch next to light switch (refer to Paragraph 3.3.9 for HVAC requirements).

3.3.6.2 Window Treatment and Coverings

All exterior windows shall be equipped with aluminum or vinyl Venetian blinds, draperies, or other coverings in new or like new condition as approved by Lessee. The blinds may be aluminum or plastic vertical blinds, horizontal blinds with aluminum slats of one-inch width or less, solar fabric roller shades, or an equivalent product pre-approved by the Lessee. The window blinds shall have non-corroding mechanisms and synthetic tapes. Color selection will be approved by the Lessee.

3.3.6.3 Signage

3.3.6.3.1 Building Identification

Lessor shall provide and install signage in accordance with Section 4. If the structure is located in an area where signage on the building is difficult to identify, one (1) or more suitable freestanding sign(s) is also required to be installed along the roadway to identify the location. Artwork and wording of the sign will be provided by the Using Agency.

3.3.6.3.2 Building Directories/Floor Directory

Provisions must be made for the Using Agency program functions to be included in the floor directory when located in a building with multiple floors. All signage related to the Using Agency must be approved by the Using Agency.

3.3.6.3.3 Building Signage Doors—Identification

All signage required in Amenity Areas unrelated to Lessee identification shall be provided and installed by the Lessor.

3.3.6.3.4 Using Agency Suite—Door Identification

Door identification shall be installed in approved locations adjacent to office entrances as part of the TIs. Interior room doors must be lettered or have nameplates attached as required by the Lessee. Lessee will provide a door-lettering schedule for the interior doors. The form of door identification shall be approved by the Using Agency. Workstation signage will be provided by the Using Agency.

3.3.6.4 Lockers

If required in Section 4, lockers shall be constructed of a synthetic material and GREENGUARD certified with minimum dimensions of 12-inch width by 12-inch depth by 60-inch height. Accessories to include one (1) shelf, one (1) j-hook, and door hasp capable of accommodating a personal locking device.

3.3.6.5 Flag Poles

Two (2) ground-mounted flagpoles with 30-feet aboveground height shall be provided at a mutually agreed upon location on the premises. Pole finish shall be satin-brushed aluminum. The flagpoles shall be illuminated. Design shall be in accordance with ANSI/National Association of Architectural Metal Manufacturers (NAAMM) *FP1001-07 Guide Specifications for Design of Metal Flagpoles*. Flags to be provided by Using Agency.

3.3.6.6 Furnishings

3.3.6.6.1 Modular Furniture (Workstations)

Each configuration of the modular units will be pre-wired by the furniture manufacturer to provide electrical service to each unit. Each modular unit must be wired to meet all voice/data and electrical requirements and is the responsibility of the Lessor. Using Agency will supply either a pre-wired power pole or a base power in-feed, both of which have an extension of 60 inches in order to hardwire the electrical system to the building's electrical supply.

It is the responsibility of the Lessor to review the modular furniture configurations and determine the number of circuits required to meet federal, state, and local electrical codes. The Lessor is also responsible for determining the entry points for bringing the voice/data wiring into the modular units as well as the hardwire locations with furniture vendor. If it is coming from a wall, column or floor, a base power in-feed will be utilized. Using Agency prefers this whenever possible.

If the modular furniture is in an open area and not against columns or walls, then power poles shall be utilized, and the Lessor will hardwire the connections in the ceiling. In wiring the system into the building's electrical supply, the isolated ground receptacle circuits shall have a dedicated insulated ground wire that is separate from the normal ground. The modular furniture will require a minimum of four (4), duplex rectangle receptacles. The modular furniture systems are equipped with raceways that allow for installation of the necessary wiring to individual units. These raceways should be used by the Lessor for this purpose.

A flush mounted faceplate should be used which will recess the voice/data jacks for a cleaner appearance. The location and size of the cutout should be reviewed with the furniture supplier. The position of jacks is in the raceway. Using Agency will provide separate communication poles for voice/data wiring where required.

Where modular furniture is being utilized in private offices, it is the responsibility of the Lessor to locate the duplex receptacles and voice/data jacks so they are not obstructed by the furniture and must be coordinated with the furniture vendor. When a new lease of space is for the same site as the current lease, it is the Lessor's responsibility to disconnect power and communication wiring to modular furniture that is scheduled to be removed/replaced. One (1) additional data communication jack shall be installed at the end of each modular unit configuration where printer locations are identified on final floor plans. Modular furniture to be provided by Lessee.

3.3.6.6.2 Free Standing Shelving Units

Lessor shall provide adjustable steel shelving units of commercial grade adjustable steel. Shelves should be adjustable in height at 1½-inch intervals; accessible from all four (4) sides to maximum accessibility; all units should be 84 inches high with depths available at 12 inches, 18 inches, and 24 inches in order to facilitate the maximum usage of the room size. The Using Agency will specify depth requirements based on stock room configuration. Shelving units should have a base shelf to assure supplies will not be on the floor, and a top shelf with four (4) adjustable shelves in between giving a total of six (6) surfaces to utilize on each unit. Shelving widths should be no less than 36 inches wide and no more than 60 inches wide with a minimum weight capacity no less than 250 lbs per shelf. Shelving units should be ganged together when set up side-by-side or back-to-back and perimeter shelving units are to be anchored to the wall.

3.3.6.6.3 Coat Racks

Coat rack areas shall be 18 inches deep. A rod shall extend across the entire width as shown on the CDs and be mounted 60 inches from the floor. This rod must be of sufficient strength to support the coats hung on it without bending or sagging. A 12-inch deep shelf (by the width shown on the CDs) shall be mounted 6 inches above this rod and flush with the rear wall. Locations to be designated by Using Agency.

3.3.6.6.4 Mail Processing Table

Construct a 6-foot by 3-foot table with laminated finish (all surfaces), 30 inches high to top of table and storage beneath with cupboard-type doors.

3.3.6.6.5 Mail Distribution Unit

This is a freestanding unit, to be constructed by the Lessor, for use in making distribution of mail in one or more locations to various staff members. The basic unit may be installed in several places throughout the office. The total number of bins in the entire office will be approximately 80 percent (80%) of the total staff. A typical diagram is shown below as a reference.

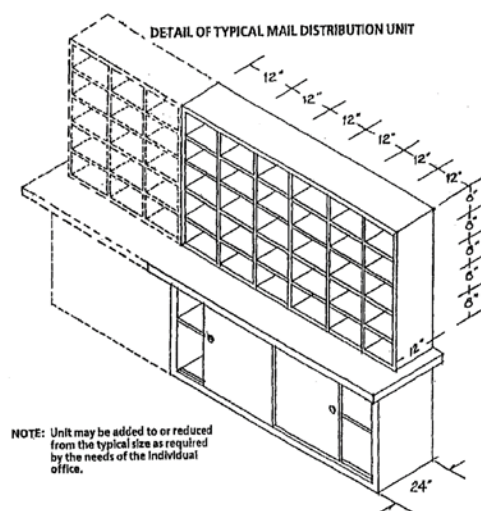

3.3.6.6.6 High Density Files

The minimum floor load shall be 320 lbs per square foot.

The Uniform Construction Code requires that as a minimum, floors be designed to support the dead load of the floor and the required live load. For an office building, the live load is normally a uniform load of 50 lbs per square foot (PSF) over the entire tributary floor area for a framing member of a 2,000-pound load placed upon any space 2 feet ½ inch square (6.25 square feet). The load producing the greatest stress in framing member is the governing load for that matter.

The requirement to design a floor for a uniform load of 50 PSF over the entire tributary area for a particular member does not mean that this is the largest load that can be placed on the floor. The load is an average value for typical office space with desks, filing cabinets, aisles, etc. The concentrated load requirement of 2,000 lbs in 6.25 square feet dictates a minimum load capacity of 320 PSF. The high loading assumes the area around the concentrated load is unloaded. This would occur if the heavy object were surrounded by aisle space. Each loading condition must be reviewed individually.

3.3.6.6.7 Bulletin Boards

Boards must have frames to match interior décor. Quantity and locations to be identified in Paragraph 4.3.

3.3.7 Division 14—Conveying Equipment

3.3.7.1 Elevators

The Lessor shall provide suitable passenger and freight elevator service to any part of the Premises not having ground-level access. The freight elevator must be accessible to the loading areas.

Speed: the passenger elevators shall have a capacity to transport in five (5) minutes 15 percent (15%) of the normal population of all upper floors (based on 150 square feet per person). Further, the dispatch interval between elevators during the up-peak demand period shall not exceed 35 seconds.

Interior Finishes: Elevator cab walls shall be hardwood, marble, granite, or an equivalent pre-approved by the Lessee. Elevator cab floors shall be marble, granite, terrazzo, or an equivalent pre-approved by the Lessee.

3.3.8 Division 22—Plumbing

3.3.8.1 Plumbing

Hot and cold-water risers and domestic waste and vent risers, installed and ready for connections that are required for TIs, shall be included in the Rent. All plumbing systems shall comply with the PAUCC.

3.3.8.2 Plumbing Fixtures—Water Conservation

For new installations and whenever plumbing fixtures are being replaced (replacement per floor is required prior to Lease Commencement in all instances of nonconformance where the Lessee occupies the full floor), water closets and urinals must conform to EPA WaterSense or fixtures with equivalent flush volumes must be utilized. Faucets must conform to EPA WaterSense or fixtures with equivalent flow rates must be utilized. Information on EPA WaterSense fixtures can be found at <http://www.epa.gov/watersense/>.

3.3.8.3 Restrooms

Lessor shall provide water closets, sinks, and urinals on each floor that is partially or fully occupied by the Lessee in accordance with all Regulatory Requirements. Separate restroom facilities for men and women shall be on each floor occupied by the Lessee in the building. Water closets and urinals shall not be visible when the exterior door is open. Lessor is responsible for providing and maintaining all restroom supplies.

Each main restroom shall contain the following:

- a. A mirror and shelf above the lavatory,
- b. A toilet paper dispenser in each water closet stall that will hold at least two rolls and allow easy, unrestricted dispensing,
- c. A coat hook on the inside face of the door to each water closet stall and on several wall locations by the lavatories,
- d. At least one (1) modern paper towel dispenser, soap dispenser, and waste receptacle for every two (2) lavatories,
- e. A coin-operated sanitary napkin dispenser in women's restrooms with a sanitary napkin waste receptacle in each water closet stall,
- f. A disposable toilet seat cover dispenser,
- g. A counter area of at least 2 feet 0 inches in length, exclusive of the lavatories (however, it may be attached to the lavatories) with a mirror above and a ground-fault interrupter-type convenience outlet located adjacent to the counter area. The counter should be installed to minimize pooling or spilling of water at the front edge, and
- h. A floor drain in new construction and during large scale renovations.

3.3.8.4 Drinking Fountains/Water Coolers/Bottle Filling Stations

On each floor of Lessee-occupied space, the Lessor shall provide drinking fountains in accordance with applicable codes including but not limited to PAUCC and the ADA. Freestanding water coolers or bottle filling stations are an acceptable alternative to drinking fountains; and Lessor is responsible to maintain a sufficient supply of full water jugs at all times.

3.3.9 Division 23—Heating, Ventilating, and Air Conditioning (HVAC)

The specifications in this Section are intended to apply when new systems are installed or existing systems are modified.

3.3.9.1 Building Systems

HVAC systems shall be designed and operated in accordance with the PAUCC. Whenever requested, the Lessor shall furnish Lessee, at Lessor's expense, a report by a registered professional engineer(s) showing that the building and its systems, as designed and constructed, will satisfy the requirements of this Lease.

3.3.9.2 HVAC—Shell

Central HVAC systems shall be installed and operational, including, as appropriate, main and branch lines, Variable Air Volume (VAV) boxes, dampers, flex ducts, and diffusers, for an open office layout, including all Amenity Areas. The Lessor shall provide conditioned air through medium-pressure ductwork at minimum ventilation rates as required by the PAUCC per ABOA SF. Systems shall be designed with sufficient systems capacity to meet all requirements in this Lease.

Lessor shall provide HVAC systems required to maintain conditions in accordance with the temperature and humidity setpoints specified in Section 2.

Areas having excessive heat gain or heat loss or affected by solar radiation at different times of the day, shall be independently controlled.

Equipment Performance: Temperature control for office spaces shall be provided by concealed central heating and air conditioning equipment. The equipment shall maintain space temperature control over a range of internal load fluctuations of plus 0.5 watts per square foot (W/SF) to minus 1.5 W/SF from initial design requirements of the tenant.

Ductwork Re-Use and Cleaning: Any ductwork to be reused or to remain in place shall be cleaned, tested, and demonstrated to be clean in accordance with the National Air Duct Cleaners Association (NADCA) *Standard for Assessment, Cleaning and Restoration of HVAC Systems*. The cleaning, testing, and demonstration shall occur immediately prior to Lessee occupancy to avoid contamination from construction dust and other airborne particulates.

Restrooms shall be properly exhausted through mechanical means, with a minimum of 50 cubic feet per minute (cfm) per water closet and urinal where periods of heavy use is not expected, or 70 cfm per water closet and urinal when heavy use is likely.

3.3.9.3 Automatic Temperature Control Systems Requirements

The Lessor shall provide a nationally manufactured automatic temperature control (ATC) system to directly control the building indoor environmental conditions such as temperature levels, humidity levels and ventilation air quantities. The ATC system shall be installed on all related HVAC and exhaust fan equipment. The ATC system shall have a central monitoring station with the capabilities of trending all automatic temperature control points, reporting of alarm conditions, remote monitoring, event scheduling, time scheduling, and energy savings functions.

3.3.10 Division 26—Electrical

The Lessor shall be responsible for complying with PAUCC requirements. When codes conflict, the more stringent standard shall apply. Main service entrances and equipment must be kept in a secured area accessible by only qualified personnel. All floors shall have 120/208 V, 3-phase, 4-wire with ground, 60 hertz electric service available.

Main power distribution switchboards, distribution, and lighting panel boards shall be circuit breaker type with copper buses that are properly rated to handle the calculated fault current. All power distribution panel boards shall be supplied with separate equipment ground buses. All power distribution equipment shall be required to handle the actual specified and projected loads with 10 percent (10%) spare load and circuit breaker space capacity. Fuses and circuit breakers shall be plainly marked or labeled to identify circuits or equipment supplied through them.

3.3.10.1 Lighting—Shell

Interior Fixtures: High efficiency T-8, T-5, or light-emitting diode (LED) light fixtures (and associated ballasts or drivers) with a color temperature of 3500K shall be installed as either ceiling-grid or pendant-mounted for an open-office plan. Ceiling-grid fixtures shall be either 2 feet wide by 4 feet long or 2 feet wide by 2 feet long. Lamps shall maintain a uniform color temperature and a minimum color-rendering index of 85 throughout the Lease term.

Lighting Levels: Fixtures shall provide 30-50 foot-candles average maintained at desktop level (30 inches above finished floor) and have dimming controls, with a maximum uniformity ratio of 1.5:1. Lessor shall provide 10 average foot-candles in all other building areas within the Premises with a uniformity ratio of 4:1. Emergency egress lighting levels shall be provided in accordance with the current edition of NFPA 101: *Life Safety Code* and the local applicable building codes (but not less than 1 foot-candle) by either an on-site emergency generator or fixture-mounted battery packs.

Power Density: (a) existing buildings—maximum fixture power density shall not exceed 1.0 watts per ABOA SF and (b) new construction—maximum fixture power density shall not exceed 0.82 watts per ABOA SF.

Daylighting Controls: If the Lease is more than 10,000 ABOA SF, the Lessor shall provide daylight dimming controls in atriums or within 15 feet of windows and skylights where daylight can contribute to energy savings. Daylight harvesting sensing and controls shall be either integral to the fixtures or ceiling-mounted and shall maintain required lighting levels in workspaces.

Occupancy/Vacancy Sensors: The Lessor shall provide ceiling-mounted occupancy sensors, vacancy sensors (preferred), or scheduling controls through the building automation system (BAS) throughout the Premises in order to reduce the hours that the lights are on when a particular space is unoccupied. No more than 1,000 square feet shall be controlled by any one sensor. Occupancy sensors in enclosed rooms shall continue to operate after the BAS has shut down the building at the end of the workday.

3.3.10.2 Building Perimeter

Exterior parking areas, vehicle driveways, pedestrian walks, and the building perimeter lighting levels shall be designed per Illuminating Engineering Society (IES) standards. Provide 5 foot-candles for doorway areas, 3 foot-candles for transition areas, and at least 5 foot-candles throughout the parking lot. Parking lot fixtures shall provide a maximum to minimum uniformity ratio of 10:1.

If the leased space is 100 percent (100%) occupied by Lessee, all exterior parking lot fixtures shall be Dark Sky compliant with no property line trespass.

Parking Structures: The minimum illuminance level for parking structures is 5 foot-candles as measured on the floor with a uniformity ratio of 10:1.

Parking Sensors: If the leased space in the building is 100 percent (100%) occupied by Lessee, exterior parking area and parking structure lighting shall be sensor or BAS controlled in order that it may be programmed to produce reduced lighting levels during non-use. This non-use time period will normally be from 11:00 p.m. to 6:00 a.m.

Exterior Power Backup: Exterior egress, walkway, parking lot, and parking structure lighting must have emergency power backup to provide for safe evacuation of the building.

3.3.11 Division 27—Communications

3.3.11.1 Telecommunications—Distribution and Equipment

Sufficient space shall be provided on the floor(s) where the Lessee occupies space for the purposes of terminating telecommunications service into the building. The building's telecommunications closets located on all floors shall be vertically stacked. Telecommunications switch rooms, wire closets, and related spaces shall be enclosed. The enclosure shall not be used for storage or other purposes and shall have door(s) fitted with an automatic door closer and deadlocking latch bolt with a minimum throw of 1/2 inch. The telephone closets shall include a telephone backboard constructed of one (1) 4 feet by 8 feet sheet of 3/4-inch plywood attached to the wall for mounting infrastructure and telecom equipment.

Telecommunications switch rooms, wire closets, and related spaces shall meet applicable Telecommunications Industry Association (TIA), Electronic Industries Alliance (EIA) and applicable NFPA standards. These standards include, but are not limited to, the following:

- a. TIA/EIA-568, Commercial Building Telecommunications Cabling Standard
- b. TIA/EIA 569, Commercial Building Standard for Telecommunications Pathways and Spaces
- c. TIA/EIA-570, Residential and Light Commercial Telecommunications Wiring Standard
- d. TIA/EIA-607, Commercial Building Grounding and Bonding Requirements for Telecommunications Standard
- e. NFPA 70: *National Electrical Code* (for bonding and grounding)

3.3.11.2 Telecommunications—Local Exchange Access

The Lessee may elect to contract its own telecommunications (voice, data, video, Internet, or other emerging technologies) service in the Premises. The Lessee may contract with one (1) or more parties to have network wiring (or other transmission medium) and telecommunications equipment installed.

The Lessor shall allow the Lessee's designated telecommunications providers access to utilize existing building wiring to connect its services to the Lessee's space. If the existing building wiring is insufficient to handle the transmission requirements of the Lessee's designated telecommunications providers, the Lessor shall provide access from the point of entry into the building to the Lessee's floor space, subject to any inherent limitations in the pathway involved.

The Lessor shall allow the Lessee's designated telecommunications providers to affix telecommunications antennas (high frequency, mobile, microwave, satellite, or other emerging technologies), subject to weight and wind load conditions, to roof, parapet, or building envelope as required. Access from the antennas to the Premises shall be provided.

The Lessor shall allow the Lessee's designated telecommunications providers to affix antennas and transmission devices throughout the Premises and in appropriate Amenity Areas frequented by the Lessee's employees to allow the use of cellular telephones and communications devices necessary to conduct business.

3.3.11.3 Communication Lines

Subject to all applicable governmental requirements and restrictions, Lessee shall have a non-exclusive right to install, maintain, upgrade, operate, repair and replace, at Lessee's cost, on the roof of the Premises Rooftop Communication Devices (RCDs).

RCDs may include, without limitation, a back-up generator, transmitter(s), microwave or satellite dishes or antenna(s), or other communications fixtures or equipment utilized for receiving or transmitting voice, video, data, or other communications, together with all wiring, equipment, and facilities reasonably necessary to make the RCDs functional and connected with the Premises.

The RCDs shall be for the sole use of Lessee in the operation of their business within and outside the Premises (including, without limitation, public broadcast services), but not for any sublicense for profit.

Subject to all applicable governmental requirements and restrictions, Lessee shall have a non-exclusive right to interconnect the RCD with Lessee's other equipment located in the Premises using risers, conduits, chases, and other mutually agreeable locations in the Premises.

If the Lessee desires to install voice, data, or other communications lines (including, without limitation, fiber optic lines) to the Premises, or to communications equipment devices serving the Premises, but located outside of the Premises, Lessor shall approve, which approval shall not be unreasonably withheld, delayed, or conditioned, (a) the allocation of space in risers and conduits not installed by Lessee; (b) the installation of risers and conduits by Lessee; and (c) the use of mechanical or equipment space and appropriate shielding.

In the event of any conflict between any use or installation made or proposed to be made, by Lessee with any other occupants, tenants, or users of Lessor's building, if such conditions should exist, Lessor shall use its good faith best efforts to afford Lessee priority in such use or installation of communication lines, consistent with Lessor's existing obligations to other occupants, tenants, or users of Lessor's building and Lessor's operation of their building.

Lessor shall cooperate with Lessee in establishing protocols enabling Lessee and Lessee's contractors to obtain immediate access to communications rooms within the Premises and Lessor's building(s) that contain Lessee's communications equipment.

3.3.11.4 Data Distribution

The Lessor shall be responsible for the purchasing and installation of data cable. The Lessor shall safely conceal data outlets and the associated wiring used to transmit data to workstations in floor ducts, walls, columns, or below access flooring. The Lessor shall provide as part of the TIs, outlets with rings and pull strings to facilitate the installation of the data cable. When cable consists of multiple runs, the Lessor shall provide ladder type or other acceptable cable trays to prevent cable from coming into contact with suspended ceilings or sprinkler piping. Cable trays shall form a loop around the perimeter of the Premises such that they are within a 30-foot horizontal distance of any single drop.

3.3.12 Division 28—Safety and Security

3.3.12.1 Security System

Provide a security system to alarm audibly within the building and annunciate at a central remote station upon unauthorized intrusion into the leased space twenty-four (24) hours a day, seven (7) days a week. Provide a seven (7) day changeable program for this system. Provide and install a dedicated voice analog/digital telephone line. Lessor shall maintain the security system in accordance with Section 2.

3.3.12.1.1 Security and Locking

Provide an automated perimeter-type security system with intrusion alarm and motion detection in all areas. Provide a key fob or keycard security and locking system with access into area via a proximity card-reading sensor system, electronic keypad system, or such other locking system as specified and approved by Using Agency. All activity of so designed systems shall be programmable through a central controller, extended keyboard, and printer. If a computer and software is required to operate the system, the Lessor shall be responsible to provide this equipment. The system shall be capable of identifying and controlling use through unique card codes. All activating and de-activating of cards will be at the sole cost of the Lessor. The system shall include twenty-four (24) hour monitoring by a manned central station capable of alerting appropriate individuals or organizations based on the time and type of alarm. All monitoring fees of any of these systems are the sole responsibility of the Lessor. Prior to installation, all equipment must be approved by the Using Agency and any applicable federal, state, or local jurisdictions regulating such installations. The Using Agency may request and receive a new locking system and/or associated hardware after a break-in or a series of thefts or other similar, unusual occurrences.

Keyless Entry Doors: Push button and/or keyless lock entry are required on any interior doors between client waiting area(s) and staff work area(s) as identified on floor plan. At least one (1) door must be equipped with a keyless entry system for employee building access. *Note: If proposed space is on two (2) levels, then an additional one (1) or two (2) security locks may be required.*

Security Push Button Locks: Manufacturers, for the purpose of establishing a standard of quality for both the product and installation, shall install Model: ILCO Unican 1000 Series, lever type. Installation of equivalent models, provided by other manufacturers, requires prior approval of the Using Agency.

Swipe Card Entry Access: The main entry to the premises from any Amenity Area shall be secured by a swipe card system that is compatible with the Using Agency's identification badges. Multi-level office space shall be protected by a swipe card system at each floor level, including outside access and/or elevator lobby access.

3.3.12.2 Fire Alarm System

A building-wide fire alarm system shall be installed in the entire building in which any portion of the space is located on the third floor or higher. The fire alarm system shall be installed in accordance with the requirements of the Uniform Construction Code (UCC), International Building Code (IBC), and Authority Having Jurisdiction (AHJ) requirements in effect on the actual date of installation. The system must also comply with all other applicable Regulatory Requirements.

The fire alarm and evacuation system shall be audible and visual and shall be operational twenty-four (24) hours a day, seven (7) days a week.

The fire alarm system shall transmit all fire alarm signals to the local fire department via any of the following means: (a) directly to the local fire department, (b) to the (911) public communications center, (c) to a central station, (d) to a remote supervising station, or (e) to a proprietary supervising station.

If the building's fire alarm control unit is over twenty-five (25) years old as of the Execution Date of this Lease, Lessor shall install a new fire alarm system in accordance with the requirements of this paragraph prior to acceptance and occupancy of the space.

3.3.12.3 Automatic Fire Sprinkler System

Any portion of the space located below-grade, including parking garage areas, and all areas in a building referred to as "hazardous areas" (defined in NFPA 101: *Life Safety Code*) that are located within the entire building (including non-Commonwealth areas) shall be protected by an automatic fire sprinkler system or an equivalent level of safety.

Automatic fire sprinkler system(s) shall be installed in accordance with the UCC, IBC and AHJ requirements in effect on the actual date of installation. The system(s) must also comply with all other applicable Regulatory Requirements.

3.3.12.4 Radon

The Lessor is responsible to provide space in which radon levels in air are below the action levels recommended by the EPA. If space planned for occupancy by the Lessee is on the second floor above grade or lower, prior to occupancy, the Lessor shall hire a professional radon specialist to test the Premises for two (2) to three (3) days using charcoal canisters. After the initial testing, a follow-up test for a minimum of ninety (90) days using alpha track detectors shall be completed. For further information on radon, visit: <https://www.epa.gov/radon>. The Lessor shall provide the results of the testing to Lessee upon request.

If radon is detected at or above the EPA recommended action levels at any time prior to Lessee occupancy, the Lessor shall carry out a corrective action program that reduces the concentration to below the EPA recommended action levels prior to Lessee occupancy. All measures to accommodate delay of occupancy, corrective action or follow-up measurement will be at Lessor's sole cost and expense.

3.3.13 Division 32—Exterior Improvements

3.3.13.1 Parking Area

If provided, paved parking preference is to be adjacent to the building. The accessible parking space(s) must be configured and appropriately marked in accordance with ADA standards. In addition, the space(s) must be appropriately identified with signage in accordance with parking regulations contained in the 2010 Pennsylvania Code Title 75—VEHICLES, Chapter 33 - *Rules of the Road in General*, Section 3354(d)(3)(i). Reference R7-8 and R7-8B, Internet, Pennsylvania Department of Transportation (PennDOT), Publications, *Bulletin 15 (Publication 35) Qualified Products List for Contractors*, Section 1103.04 Flat Sheet Signs (Post Mounted Types B, C, and F; and Distance Markers), and PennDOT *Publication 236, Handbook of Approved Signs*. Materials and workmanship shall conform to the latest applicable requirements of PennDOT Specifications. The paved parking area must be striped and numbered to provide the number of stalls specified. Entrance and exit signs must be installed. Lessor will be responsible to provide signage for direction and clarification in lots that are shared or not adjacent to the building. Double-parking and blocked-in parking spaces may not be counted toward meeting minimum requirements. Furnish and install, in locations as required, pre-cast concrete bumper guards. Individual stall signage must be erected, if requested, and approved by Using Agency.

3.3.13.2 Loading Dock

The Lessor shall provide a loading dock for shipping and/or receiving. If applicable, the bay type needed is identified in Section 4 and will be one of the following:

- a. Bay No. 1: 12 feet wide with a dock height of 2 feet above the road surface and a dock leveler included. Dock access should be covered with 7-foot wide, double-swinging doors or overhead entry doors to a vestibule protected from the weather.
- b. Bay No. 2: 12 feet wide with a 4-foot road surface to dock height and a hydraulic dock leveler. Dock access should be covered access with 7-foot wide, double-swinging doors or overhead entry doors to a vestibule protected from the weather. An adjoining stair from the road surface to the dock should

be provided. Space inside the dock area for staging deliveries must accommodate up to twenty (20) pallets of incoming and outgoing materials.

3.3.13.3 Secure Staging/Storage Area

If required in Section 4, the Lessor shall provide a secure staging area accessible by pallet jack from the loading dock. Ceiling height of this space shall be a minimum of 9 feet. The entry door to this space must be a minimum of 4 feet wide. Lessor shall provide separate, secure space for Lessee.

3.3.13.4 Canopy

Large canopy of permanent type construction must be installed at each entrance and exit to provide protection to employees and/or visitors from the outside elements, in accordance with the general décor of the building. Lessor will pay the expenses for the maintenance and installation of the canopy.

3.3.13.5 Cigarette Urns

Provide exterior cigarette urn(s) near entrances and exits with designated smoking areas identified with appropriate signage. Urns shall be attached to the building or ground to prevent theft or vandalism.

4 Agency Space Requirements – DHS CAO – Sullivan County

(Information in this section defines any Agency specific needs to be provided by the Lessor and must be coordinated with Section 3)

4.1 General Requirements

- 4.1.1 All work required to complete renovations in buildings that remain occupied by the Using Agency must be completed after normal hours of operation as defined in the Lease unless otherwise agreed to between the Parties.
- 4.1.2 All work within space must meet ADA requirements.
- 4.1.3 In accordance with Section 2.5.10.2, Lessor must provide the Using Agency with SDS sheets for all products to be used during construction prior to the Pre-Construction Meeting referenced in Section 3.2.4.
- 4.1.4 In accordance with Section 3.1.13, Lessor must provide the Using Agency with a copy of the asbestos certification inspection report prior to the Pre-Construction Meeting referenced in Section 3.2.4.
- 4.1.5 Lessor shall cooperate with the Using Agency to design and coordinate all activities, including, but not limited to, the following:
 - a. Preliminary Design/Site Visits
 - b. Final Review/approval of Architectural Floor Plan
 - c. Agency Review of Submittals (color/finish selections - paint, carpet, signage, room names, door hardware, keying)
 - d. Pre-Construction Meeting
 - e. Agency security requirements
 - f. Agency identified copier/printer locations
 - g. Coordination with Using Agency vendors for IT, furniture, relocation services
 - h. Final Acceptance Inspection – to be coordinated with BRE and the Using Agency (GSRE-42N form to be completed and signed by all parties)
 - i. Staff Relocation

4.2 Exterior Design—Site Requirements

4.2.1 Building Signage

Signage shall be provided on the building and on glass entrance doors. Lessor will also provide additional signage along street by the parking lot entrances (if needed). The signage on the doors shall be vinyl, include the logo for the Pennsylvania Department of Human Services, and the name “Sullivan County Assistance Office”. The signage along the street shall include the words “PENNSYLVANIA DEPARTMENT OF HUMAN SERVICES” and the logo for the Pennsylvania Department of Human Services. Street signage size will be dependent on the location and what is permissible by local ordinance. The agency will provide the specifics and must approve the signage.

The suggested form is a sign 36 inches by 26 inches rectangular and may not be altered in anyway. The sign shall be weatherproof material with square corners and edges. The sign will consist of the Using Agency’s logo centered with a blue rule going around the logo, encompassing the wording on the sign. The county name “Sullivan” is to be Verdana typeface, size 204 pt, 5 kerned. The words “County Assistance Office” are to be upper and lower cased in Verdana typeface, size 160 pt, no kerning. Colors to be used are PMS 281 for lettering, and white enamel background. The rule is 12 pt thickness and 1 inch from left, right, and bottom of the sign. *A sample sign is shown below:*



4.2.2 Parking Area

The parking area must be constructed in accordance with Section 3. A minimum of **10-12** parking spaces must be provided on-site.

4.2.3 Drop Box

Lessor will provide an all-weather, 24-hour accessible locking "Client Drop Box". The drop box should be located near the client entrance in an easily identifiable and ADA accessible area for clients. Box can be stand alone or installed in exterior wall of lobby. If the drop box is installed in the exterior of the lobby, a mail slot accessible for after hours, weather tight, and with a locking secure interior holding box, shall be installed on an exterior door or wall near the front entrance.

Signage shall be provided identifying mail slot for "client drop-off only." Signage to be approved by Using Agency prior to installation.

4.3 Interior Design—Space Requirements

(Refer to Section 3 for standard construction specifications for each item in this section. Unless otherwise specified below, the standard specifications contained in Section 3 shall apply.)

A circulation factor of 35% is required for all office space and is not provided for in the square footages below. Unless otherwise specified below, all furniture and IT/Telecom equipment shall be provided by Using Agency.

4.3.1 Vestibule

The client entrance should be provided with a vestibule that will serve as an air lock to prevent from high/low temperatures entering the space. Both entrance doors shall be aluminum with full lite glass and shall be provided with automatic closers.

4.3.2 Waiting area/Client Service Area

This area is an open, interactive space inside the main entrance where clients can obtain services through multiple self-service portals and through employee interaction. The following areas will be contained within the Client Service Area/waiting area:

- a. Waiting area -This area shall consist of approximately **200** usable square feet. It is an open area inside the main office entrance where clients waiting for service can be seated.
- b. Client Computer Terminal Area (Compass) - This area shall be located between the entrance and the Reception Area and will consist of small cubicles for **1** computer terminals and shall be oriented to prevent direct views of computer screens while clients are completing online applications. Lessor to provide voice/data and electrical lines to accommodate network capabilities. Lessee to provide furniture.
 - Number of **5' x 3'** Compass Stations: **1**
- c. Self-Service Telephone Area – This area must be wired to accommodate **1** wall-mounted telephone. Lessor to provide one (1) 30-inch high by 24-inch-wide counter with privacy shields approximately 20 inches high, to be evenly spaced between each telephone, which will create individual stations and ensure confidentiality to clients.
- d. Self-Service Application Counter – Lessor to provide a counter 30 inches high by 24 inches wide and approximately 8–10 feet in length on one (1) wall.
- e. Service Data Area - This area shall consist of approximately **27** square feet and shall be large enough to accommodate a storage cabinet, a copier, and a drop box. Lessor to provide voice/data and electrical lines to accommodate network capabilities.

- f. Instructional Monitor(s) -2 large format monitor(s) provided by Lessee shall be installed in this space to provide self-service instructions to clients. The monitor(s) shall be wall-mounted or ceiling hung and shall be seen directly upon entering the office and from the client COMPASS stations. If one (1) monitor cannot accommodate both lines-of-sight, multiple monitors shall be installed. The Lessor shall provide all blocking, reinforcements, and other supplies needed to support the monitor.
- g. Lessor to install ADA compliant water bottle filling station in the waiting area. Refer to Section 3 for specific requirements.

4.3.3 Reception Area/Desk

This area shall consist of approximately **200** usable square feet. The reception desk is the control center of the office where clients make the initial contact with staff for services. Lessor shall construct the Reception Desk in accordance with the specifications contained in this paragraph. A typical Reception Area drawing is provided for reference.

Typical Reception Area 1

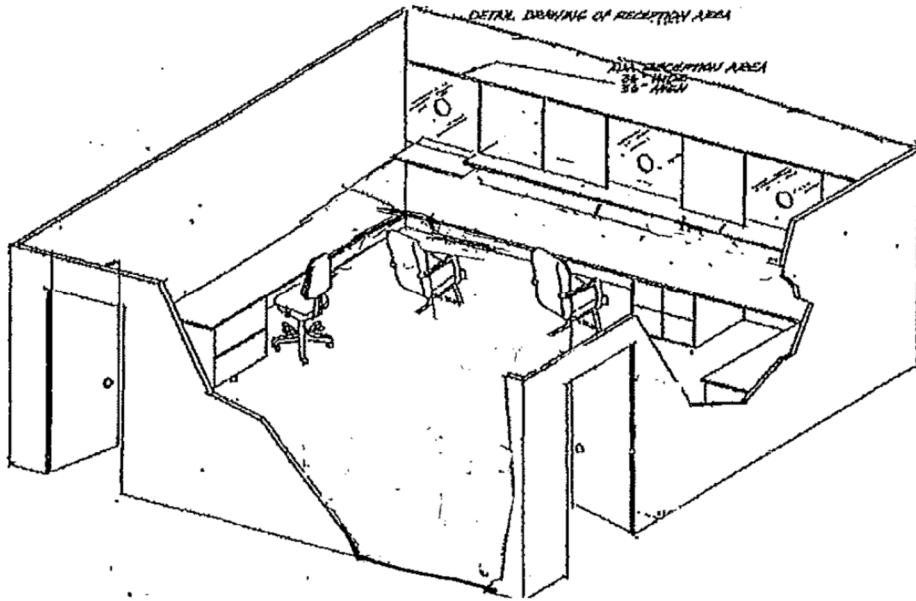

The dimension drawings below show several file cabinets under both the front counter and the return surfaces on each side. These cabinets shall be supplied by the Using Agency. Lessor must provide a 28-inch clearance under all surfaces for the installation of these cabinets. The glass enclosure should be near ceiling height or only allow for HVAC airflow, not to exceed an 8-inch opening to the ceiling. Glass windows shall be provided along the length of the reception desk with full walls extending to the ceiling above. Pass thru opening of approximately 14"x2" for documents shall be provided along with speak thru holes and metal cover for communication between staff and clients.

The following specific electrical requirements must be met:

- a. Front Counter Area: (a) eight (8) duplex electrical outlets, four (4) of which are on a common circuit, and four (4) of which are on a dedicated circuit for computer related use; and (b) four (4) duplex communication jack plates, each wired Data A and Data B.
- b. Each Return Surface: (a) one (1) duplex outlet on a dedicated circuit for computer related use and (b) one (1) duplex communication jack plate wired for data.

Typical Reception Area - Front View 1

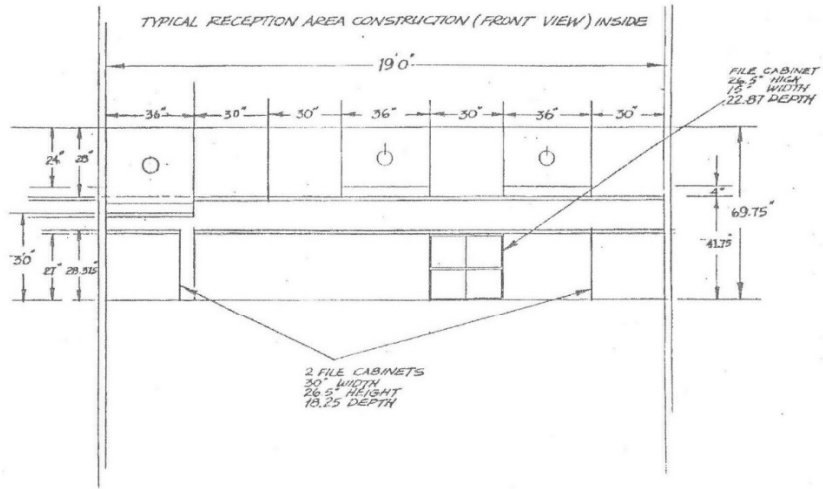

Typical Reception Area - Top View 1

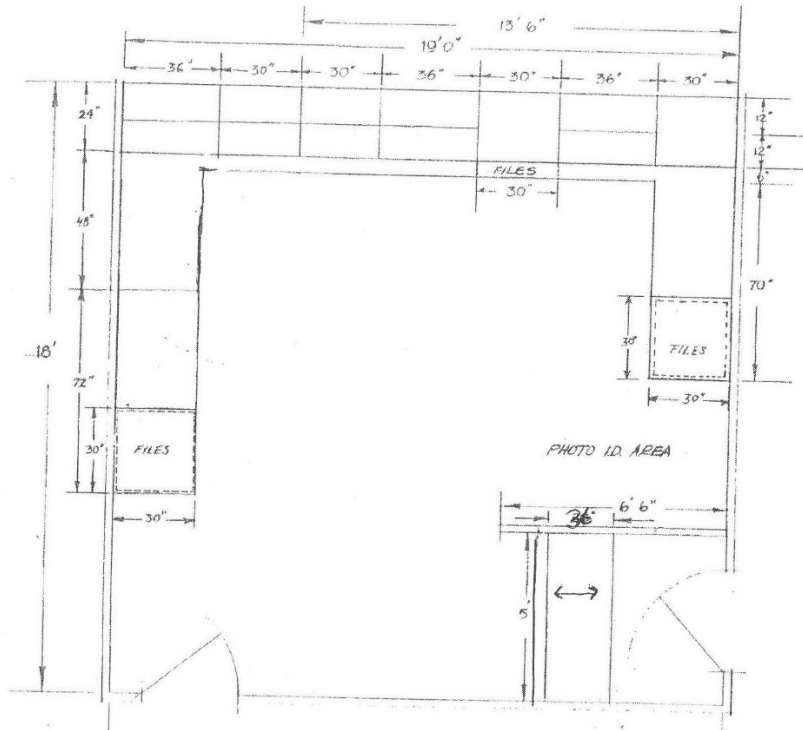

4.3.4 Interview Booth Area

This area shall consist of approximately **154** square feet. This secure area is where staff conduct face-to-face interviews with clients. A client door is required to be off the lobby area, as well as a separate staff door. The staffing area shall be secured from client access with push button keypads. Lessor shall supply programmable (by Lessee) keypads if needed to secure the space. Lessor to provide voice/data and electrical lines to accommodate network capabilities for new pre-wired workstations provided by the Using Agency. Lessor shall provide connections for workstations

- Number of **7'x11'** Workstations /Booths Required – **2**

4.3.5 Conference Room

Number required: **1**. This area shall consist of approximately **150** square feet and located in the staff area. This room shall be constructed as follows: (a) door(s) with automatic door closers; (b) wired to meet all voice/data and electrical requirements every 6 feet on each perimeter wall (responsibility of the Lessor); (c) chair rail shall be installed along the perimeter at 36 inches from floor; and (d) finish shall be natural and approximate color of interior doors. The wiring and cabling of this room must accommodate at least one (1) overhead networked projector to be connected to the trainer's computer.

4.3.6 Training Room

Number required: **1**. This area shall consist of approximately **200** square feet. This room shall be constructed as follows: (a) door(s) with keyed lock and automatic door closers; (b) wired to meet all voice/data and electrical requirements every 6 feet on each perimeter wall (responsibility of the Lessor); (c) chair rail shall be installed along the perimeter at 36 inches from floor; and (d) finish shall be natural and approximate color of interior doors.

The wiring and cabling of this room must accommodate the following:

- a. One (1) overhead networked projector, or wall mounted TV. Equipment shall be provided by the Using Agency.
- b. Ten (10) Ethernet ports
- c. Five (5) duplex receptacles

4.3.7 Client Restrooms

Public restroom(s) shall be accessible from the waiting area and be provided for both males and females in accordance with Section 3. At a minimum, a single user unisex ADA accessible restroom shall be provided with one toilet and one lavatory. If separate male and female restrooms, one urinal shall be provided in the male restroom. Baby changing stations must be provided and installed in each restroom. Lessor shall provide and install liquid soap dispenser, paper towel dispenser, and provide a five (5) gallon waste receptacle.

4.3.8 Nursing Parent's Room

A new or existing vacant private office can be used. The room shall consist of approximately **100** square feet and contain locking door hardware so that the door can be locked from the inside. Exterior hardware that displays the word "occupied" when the door is locked shall be provided. The room shall provide visual privacy to the space by modifying or covering windows, sidelights, and doors. The room shall provide sound privacy to the space to minimize sound transmission into adjacent spaces, including using sound attenuation insulation if possible. The room must comply with all electrical and voice/data requirements of this Lease. A waste receptacle must be provided. The room must contain a sink or be adjacent to a kitchenette, breakroom, or women's restroom with a sink installed in casework to provide the space necessary to clean equipment and containers, however, the room may not be a restroom, toilet stall, storage room, or janitor's closet. One (1) mini refrigerator shall be provided. A paper towel and soap dispenser shall be provided, or if the room does not contain a sink, a wet wipe dispenser shall be provided and maintained by the Lessor. A mirror, preferable of full length shall be provided. Furniture shall be provided by Lessee.

4.3.9 Open Office Area/Workstation Area

This area shall consist of approximately **448** square feet to accommodate modular furniture as designed by the Using Agency's furniture vendor. Refer to Section 3.3.6.7 for detailed specifications to prepare the space for furniture installation to include cabling and electrical requirements. Unless otherwise specified below, a typical workstation will consist of a minimum of **2** monitors, **1** telephone, headphones, scanner and task lighting. Each workstation will be prewired and contain 4 duplex outlets/8 receptacles.

- Number of **8' x 12'** Workstations: **1**
- Number of **8' x 8'** Workstations: **4**
- Number of **8' x 6'** Workstations: **2**

4.3.10 New Private Offices

Number of rooms required: **2**. These rooms shall consist of approximately **150-225** square feet each. These rooms shall be wired to meet all voice/data and electrical requirements every 6 feet on each perimeter wall (responsibility of the Lessor). Chair rail shall be installed along the perimeter at 36 inches from floor with a finish that is natural with approximate color of interior doors. Doors shall be locking with ADA lever sets.

4.3.11 Storage Room

This is a supply storage area for the Lessee. This room shall consist of approximately **200** square feet. Lessor shall provide adjustable steel shelving units in accordance with Section 3.

4.3.12 Lunchroom

This room shall consist of approximately **200** square feet. Chair rail shall be provided along the perimeter of the room at 36 inches above finish floor. Lessor shall provide and maintain one (1) microwave oven for every fifty (50) employees that is Underwriter's Laboratory (UL)/NSF International (formerly the National Sanitation Foundation) approved, 120 volt, 1,000 watts or higher, ENERGY STAR® rated, and with a dedicated circuit. Lessor shall provide and maintain one (1) refrigerator (ENERGY STAR® rated) of 23 cubic feet minimum size for every fifty (50) employees. An epoxy resin countertop, approximately six (6) feet long by three (3) feet deep and base cabinet with drawers shall be provided with a single stainless-steel deep sink with hot and cold running water and appropriate waste line. The faucet assembly shall be a stainless-steel single handle, high arc kitchen faucet with sprayer function. A quadruplex 120V, 20A, 60HZ, single phase receptacle shall be provided near the countertop. Lessor shall provide and install liquid soap dispenser, paper towel dispenser, and provide a fifteen (15) gallon waste receptacle. Lessor to provide space for two (2) vending machines and the electric to accommodate. The area must have an exhaust fan provided and installed. Lessor to install ADA compliant water bottle filling station and ADA compliant drinking fountain in the lunchroom. Refer to Section 3 for specific requirements.

4.3.13 Employee Restroom

Restrooms shall be provided for both males and females in accordance with Section 3. Male and female restrooms must be constructed in compliance with State and local sanitation requirements. Fixtures that must be provided and installed are: metal toilet compartments; metal urinal barriers, all fittings; hardware and fastenings; toilet tissue dispensers for each toilet; paper towel dispensers, one for each toilet room, soap dispensers, self-contained type, one at each lavatory fixture; waste receptacle, one in each toilet room, and one stainless steel edged mirror over each lavatory fixture. A lavatory counter covered with formica or marlite laminate is to be installed in restrooms where one or more lavatories are to be installed. A privacy barrier or partition must be erected at the entrance to all employees' restrooms to restrict view from the outside. Number of stalls and lavatories to comply with the projected staff occupancy. Lessor will provide one coin-operated sanitary napkin dispenser and separate sanitary napkin disposal unit in each ladies restroom. Lessor will furnish napkins and maintain the units. Lessor will furnish and install a "D" type furniture pull handle at a height between 40" to 44" off the floor to both sides of the handicapped metal toilet compartment doors. Ceramic tile or equivalent approved by lessee is to be installed on floors and walls to a minimum height of 4'. Purse shelves, manufactured by the Nik-O-loc Co., Equipment Division. Indianapolis, Indiana, or equal, to be installed in all toilet booths in the female restrooms.

4.3.14 Interior Signage

Each room shall have wall mounted signage as designated by the Using Agency. Lessor shall install wall mounted signage to identify the offices/rooms by given name and number. Using Agency to provide names of rooms, lessor to identify room numbers on drawings/floorplans.

4.3.15 Telecommunications Equipment Room

This paragraph provides for space requirements for this room. A diagram of a typical layout is provided below. Cabling requirements are contained in Paragraph 4.3. This room shall be as centrally located as possible on each floor to ensure that no voice or data location exceeds the 100-meter rule of the ANSI/TIA/EIA-568 standards. The door shall be equipped with a lockable passage set. The size of this room shall be as follows:

- a. Buildings up to 10,000 square feet:
 - Single-Floor Buildings: Room size approximately 111 SF
 - Buildings with more than one (1) floor shall have a main equipment room sized 6 feet by 7 feet and a similar sized room on each floor. Room locations for multiple floors shall be stacked on top of each other.
- Buildings over 10,000 square feet:
 - Single-Floor Buildings: Room size approximately 222 SF
 - Buildings with more than one (1) floor shall have a main equipment room sized 13 feet by 15 feet and a similar sized room on each floor. Room locations for multiple floors shall be stacked on top of each other.

In multi-agency buildings, agencies who require their network to have a physical separation from other agency network equipment will require the Lessor to provide secure lockable cabinets to house cabling and equipment terminations. With the exception of the

normal service power requirements identified herein, no electric/power equipment or panels, nor mechanical equipment, including building HVAC units, shall be housed in this room. There shall also be no water or drain pipes contained in this room.

The Telecommunication Equipment Room shall have a temperature-controlled cooling system completely independent from the building HVAC systems. Typically, these independent cooling systems are mini-split DX style with integral temperature controls, wall-mounted evaporator units with outdoor condensing units. The independent cooling system shall maintain a maximum space temperature set point of 72°F year-round.

The Lessor shall install tile on the floor of each Telecommunication Equipment Room. No carpeting, including anti-static carpeting, shall be used.

The Lessor shall ensure that a vertical chase (open area for cable runs between floors) or coring with sleeves is installed between the main Telecommunications Equipment Room and any Intermediate Cross-Connect (ICC) or additional Telecommunications Equipment Rooms. Service power shall be 120-volt, 60 Hz, 20 Amp.

Mounted on the extreme lower portion of the data rack shall be eight (8) duplex dedicated/isolated A/C power outlets; eight (8) duplex or four (4) quad dedicated/isolated A/C power outlets must be installed inside the data rack. Two (2) duplex conventional A/C power outlets on a common circuit shall be located on the wall as designated by the Using Agency for use with test equipment.

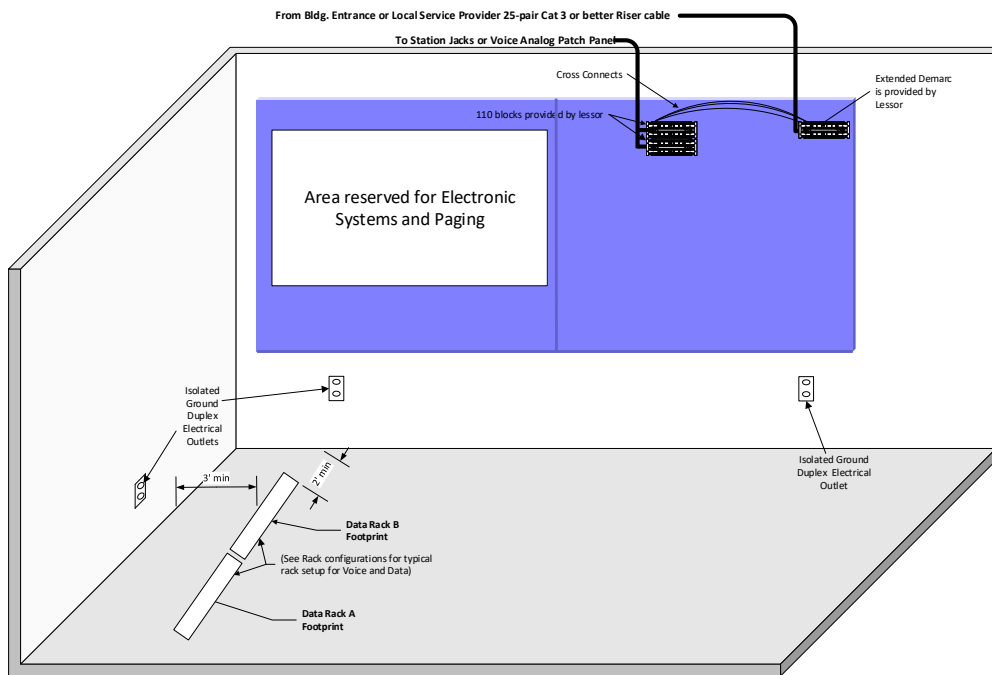

Sample Configuration of Telecommunications Room Layout

4.4 Miscellaneous Specifications

4.4.1 Intercom Paging System

The Lessor shall provide, install, and maintain a paging system consisting of speaker assemblies (speakers, transformers, grills, etc.), speaker back boxes, bridge supports, volume controls, equipment rack, and any other accessory required to provide a fully operational system. The amplifier shall be of sufficient wattage to ensure that it can adequately power the number of installed speakers with sufficient space wattage to handle a 25 percent (25%) increase in the number of speakers. Most speakers will require 1 watt of power for satisfactory operation. The paging intercom must include an adequate number of speakers throughout the Premises to ensure coverage to all areas designated by the Using Agency. The system must be equipped to provide a maximum of four (4) zones and an all-call and must have the capability of being activated from any designated telephone. One zone will be established as "all call." Other zones and speaker placements will be designated by the Using Agency. Paging speakers located in the conference room and multi-

purpose rooms must have volume controls. All wiring will be 18-gauge stranded, twisted, shielded pair. Steel or aluminum wire molding will be used wherever the cable cannot be concealed. *Note: The total number of speakers required should be based on providing one (1) speaker for every 300 square feet of area provided under this project.* Recommend the use of Bogen Pagen Control Modules like the PCM2000 and Paging Amplifiers like the TPU250, or similar

4.5 Voice and Data Cabling Requirement

The Lessor shall be responsible for providing and maintaining all voice and data requirements included in this specification unless otherwise noted. Any deviation from these specifications must be approved, in writing, by the Using Agency. The Lessor shall provide and install the entrance conduit that brings the voice and data services into the building and any required conduit and feeder cable within the building to bring services to the Telecommunications Equipment Room. A 25-pair Feeder cable is to be used within the building to extend demarcation point services will be connected to 110-type 5 pair (using C5 clips) connecting blocks on a wallboard using at a minimum Category 3 riser cabling for analog telephone, facsimile (FAX), fire and security alarms. If there is a requirement to increase the actual number of pairs to be extended to the Telecommunications Equipment Room it must be coordinated with the Using Agency Telecommunications Unit before installation. The service provider under contract with the Using Agency will be responsible for installing the cable and/or fiber facilities from the telephone company's central office to the facility where they will terminate the cable and/or fiber at a demarcation point. From this demarcation point, the Lessor and/or their designated subcontractor will be responsible for providing and installing all voice and data facilities and material within the building except for the telephone system and data equipment.

This includes, but is not limited to the following:

- a. Telecommunications Equipment Room;
- b. Main Cross-Connect (MC), also known as Main Distribution Frame (MDF);
- c. Modular patch panel equipment with associated patch cords;
- d. Voice and data wiring and hardware, including cross-connecting blocks;
- e. Power poles and/or wire moldings where required;
- f. Necessary wiring and telephone in each elevator as required.

4.5.1 General Requirements

Required installation standards of this specification shall use as the minimum, characteristics for Category 6 cable installation Placement of electrical, voice/data outlets must be located so as not to interfere with modular furniture placement. A vertical pathway or power pole is used to provide a pathway from the ceiling or horizontal pathway area when the outlet location is not adjacent to a wall. Voice and data will be run through separate power poles from the poles providing electrical power. Pathway percent fill is calculated by dividing the summation of the cross-sectional area of all cables by the most restricted cross-sectional area of the pathway. For planning furniture pathways, the maximum pathway fill shall be 40 percent (40%). A maximum of 60 percent (60%) pathway fill is allowed to accommodate unplanned additions after initial installation.

All wiring or cable for this specification will be classified as "Communication Circuits" (voice and data) and will be installed and maintained under the strict guidance of the NEC provision found in *Article 800: Communications Circuits*.

All four (4) pairs of every station cable, both voice and data, shall be terminated at both ends (wired for T568B specifications) providing continuity of all pairs from every workstation back to the appropriate MC in the Telecommunications Equipment Room. Termination at the MC shall be onto Category 6 compliant 8-pin (wired for T568B specifications) patch panel equipment.

ANSI/TIA/EIA-607 Commercial Building Grounding and Bonding Requirements for Telecommunications shall be followed.

Lessor is responsible to provide electrical, voice/data for each workstation, private office, training room, and any other workspace as identified/occupied by DHS.

4.5.2 Main Cross Connection (MC)

The MC will be located in the Telecommunications Equipment Room. The Lessor shall provide and install 110-type connecting blocks and will also provide and install eight-point modular jack patch panel equipment for all terminations.

The patch panel equipment shall be no larger than standard size 24-port, and no high-density space saver patch panels shall be used without prior approval from the Using Agency Telecommunications Unit. The patch panel equipment shall be of sufficient size to accommodate all existing infrastructure requirements and at least 15 percent (15%) spare patch panel ports for growth. The Lessor must provide and install all the patch panel hardware required to make the system operational, including all patch cords and the designated wire management panels used to dress the patch cords between the patch panels in a neat and orderly fashion. Wire management will consist of Panduit Slotted Duct Style Horizontal and Vertical Cable Management panels. Refer to the Telecommunications Equipment Parts List below for the information needed mandatory installation requirements. Any deviation from this list must be approved by the Using Agency Telecommunications Unit, in writing, detailing the changes and reason for substitution. Any substitutions proposed must meet all the same specifications and/or requirements as the original item.

Telecommunications Equipment Parts List

Description	Vendor	Part Number	Substitutable
Mini-Com TX5e Jack Module	Panduit	CJ5E88TIW	
Mini-Com Blank Module	Panduit	CMBIW-X	
Mini-Com Ultimate ID Classic Series Faceplates	Panduit	UICFP4IW	
19" Standard Rack	Panduit	CMR19X84	Yes
DP5e Patch Panel 24 port	Panduit	DP245E88110U	Yes
Standard Vertical Slotted Duct (Front and Rear) 4wX5dX83h	Panduit	WMPV45	
Standard Vertical Slotted Duct (Front only) 4xX5dX83h	Panduit	WMPVF45	
Standard Horizontal Cable Managers 19" Manager (Front only)	Panduit	WMPHF2	

4.5.3 Voice Analog Requirements

On one (1) wall designated by the Using Agency Telecommunications Unit, one (1) 4 feet by 8 feet sheet or two (2) 4 feet by 4 feet sheets of ¾-inch plywood shall be attached for mounting the MC in the Telecommunications Equipment Room for voice (if there are additional floors that have a Telecommunications Equipment Room, they are to have the same plywood installation as the MC). The plywood shall be attached in such a way that the top of the highest patch panels shall not be higher than 6 feet 2 inches and the bottom of the lowest patch panel shall be no lower than 2 feet from the floor.

The voice MC shall consist of Category 6 compliant 110-type, C4 connector blocks, mounted on the wallboard, and then terminated to the Line Side patch panels that are Category 6 (1000M) compliant 8-point modular jack patch panel equipment (wired for T568B specifications) using 25 pair Category 6 (350M) cable runs. Voice Station patch panels that are Category 6 (1000M) compliant, 8-point modular jack patch panel equipment (wired for T568B specifications) using C4 Category 6 (1000M) cable runs shall terminate to a Category 6 (1000M) compliant, 8-pin (wired for T568B specifications) RJ-45 end-user interface jack. The maximum size of the patch panel equipment will be 48 ports.

Two (2) duplex dedicated/isolated A/C power outlets shall be located on the wall directly below each piece of plywood. Two (2) additional duplex dedicated/isolated A/C power outlets, one (1) with Leviton 4720-C twists locks, shall be installed in close proximity to be used by the telephone company.

A 25-pair Feeder cable is to be used within the building to extend demarcation point services will be connected to 110-type 5 pair (using C5 clips) connecting blocks on a wallboard in the Telecommunications Equipment Room, using at a minimum Category 3 riser cabling for analog telephone, facsimile (FAX), fire and security alarms.

The 24 port voice patch panels will be installed in the 19-inch by 84-inch floor-mounted Data B rack. This panel will be mounted toward the bottom of the Data B Rack and will be required to extend to the wallboard next to the 25-pair Feeder Cable that extended the Voice Analog service.

The first set of voice patch panel equipment at the top will be designated as the Line Side patch panel. Each available port will be connected to 110-type blocks with all four (4) pairs terminated. From these cross-connecting blocks, all existing telephone lines will be cross-connected to the telephone company demarcation point. The second set of voice patch panel equipment will be designated as the station side patch panel and will have all four (4) pairs terminated to the appropriate station jacks as required.

A modular voice jack will be installed in the Telecommunications Equipment Room for use with the intercom paging systems.

4.5.4 Data Requirements

The data MC shall consist of data station patch panels that are Category 6 compliant 8-point modular jack patch panel equipment (wired for T568B specifications) using 4-pair Category 6 (1000M) cable runs that will terminate to a Category 6 (1000M) compliant, 8-pin (wired for T568B specifications) RJ-45 end-user interface jack. The maximum size of the patch panel equipment will be 24 ports.

All data patch panels shall be installed in 19-inch by 84-inch floor-mounted racks and will be Labeled and Data Rack A and Data Rack B. The top of the highest patch panels shall not be higher than 6 feet 2 inches and the bottom of the lowest patch panel shall be no lower than 2 feet from the floor. This metal floor-mounted data frame will be equipped with a #6 AWG solid copper ground wire attached to an approved water pipe ground.

4.5.5 Station Wiring

All cable will be four pair, Category 6 compliant, Type CM communications cable, 24-AWG, solid conductor, unshielded twisted pair, meeting the electrical and corresponding distance requirements of ANSI/TIA/EIA-568B. All station wiring will be home run, no intermediate cut downs, or splices, to the appropriate telecommunication room and terminated directly onto Category 6 compliant patch panel equipment. All four (4) pairs must be physically terminated at Category 6 compliant 8-pin modular telecommunication outlet and at the appropriate patch panel equipment port.

All cable shall be concealed either above a suspended ceiling, in conduit, in wire mold, or behind partitions. A maintenance loop of 6 feet to 10 feet is required to provide enough slack at the MC to accommodate any future movement of the terminating wires on their respective voice or data patch panel terminations.

ANSI/TIA/EIA-607 Commercial Building Grounding and Bonding Requirements for Telecommunications shall be followed.

4.5.6 Conduits, Power Poles and Plenum Runs

All wiring not in conduits and run in air handling plenums will have Type CMP communication plenum cable, low-smoke, heat resistant Haler type insulation. All conduits will be electrical metallic tubing (EMT) type conduit or raceways.

All access holes through floors, walls, etc. that must be drilled for the installation of voice and data facilities must be provided by the Lessor. These access holes must be equipped with a sleeve and bushings at both ends and must be properly fire-stopped at both ends.

Wire mold, conduits, or power poles shall be required to those voice and data locations where the wiring cannot be concealed or readily fished through walls, etc. All exposed voice/data cable attached to office walls, ceilings, or floors shall be concealed using approved surface raceway molding.

In multi-channel raceways, dividers separating compartments shall be bonded to ground in accordance with ANSI/TIA/EIA-607. Metal raceway bases, covers, and dividers shall be bonded and grounded in accordance to applicable codes and ANSI/TIA/EIA-607.

4.5.7 All Jacks

All wiring will be terminated on Category 6 compliant duplex data jacks, as required, at the workstation location (wired for T568B specifications).

Duplex faceplates will have two (2) 8-conductor (wired for T568B specifications) modular jacks labeled by the Lessor's Wiring Vendor as "A" for the Top Data Jack and "B" for second or bottom data jack all on a single faceplate. All end-user interface boxes must be secured with mounting screws. No double-sided tape will be permitted. The inserts of the jacks will be color-coded: orange insert for the Data Jack A and blue insert for Data Jack B. Any substitutions proposed must meet all the same specifications and/or requirements as the original item. All labeling will use permanent mechanically/electronically made markings.

4.5.8 Coding, Records, and Training

The Lessor shall prepare a cable record that will include a copy of the floor plan showing jack locations and numbering sequence, and which coincides with the patch panel port labeling. All voice and data 8-pin modular locations at the end-user station jack and at the patch panel equipment shall be labeled with permanent mechanically/electronically made markings by the Lessor for identification by the Using Agency. The numbering scheme should be kept constant and consecutive (*i.e.* A1/B1.....A288/B288) throughout the entire site. One (1) copy of this record must be submitted to the Using Agency prior to final acceptance of the facility.

4.5.9 Cable Certification Testing

The Lessor and/or his designated subcontractor will be responsible for performing testing of all voice and data wiring and hardware to assure compliance with equipment specifications. The Lessor and/or his designated subcontractor must provide the Using Agency with a complete copy of all test results prior to final acceptance of the facility. Test results shall be in numerical sequence; voice and data will be separate. All testing will follow ANSI/TIA/EIA-568 standards. At a minimum, the test results for each jack, voice and data, must contain the jack number, cable length, wire map, attenuation, NEXT (Near End Cross Talk), and cable impedance.

4.5.10 Patch Panel Requirements

Standard size hinged 24-port panel. A minimum of 15 percent (15%) spare patch panel ports will be provided for growth. Panduit wire management panels will be used to dress all cabling front and in back of the rack. Panduit Slotted Duct Style Wire Management Panels will be used between each 24-port unit as well as on the sides. Panels will be labeled with permanent mechanically/electronically made marking. All Data patch panels will be mounted within a floor-mounted 19-inch by 84-inch racks. Spare patch cords will be supplied for voice and data panels. A minimum of 15 percent (15%), the number of each spare cord length (3 feet, 5 feet, and 7 feet) will reflect percentages of those used during the installation (80 percent [80%] of the patch cords should be 3 feet in length).

4.5.11 Diagrams

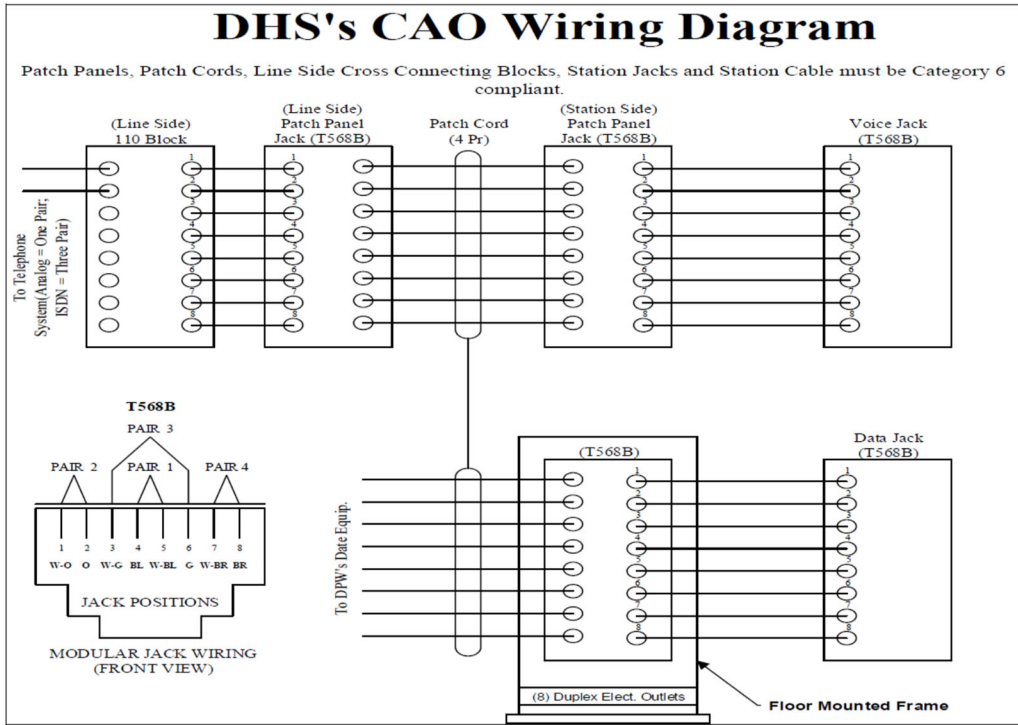

Voice/Data Rack Layout - Small Office

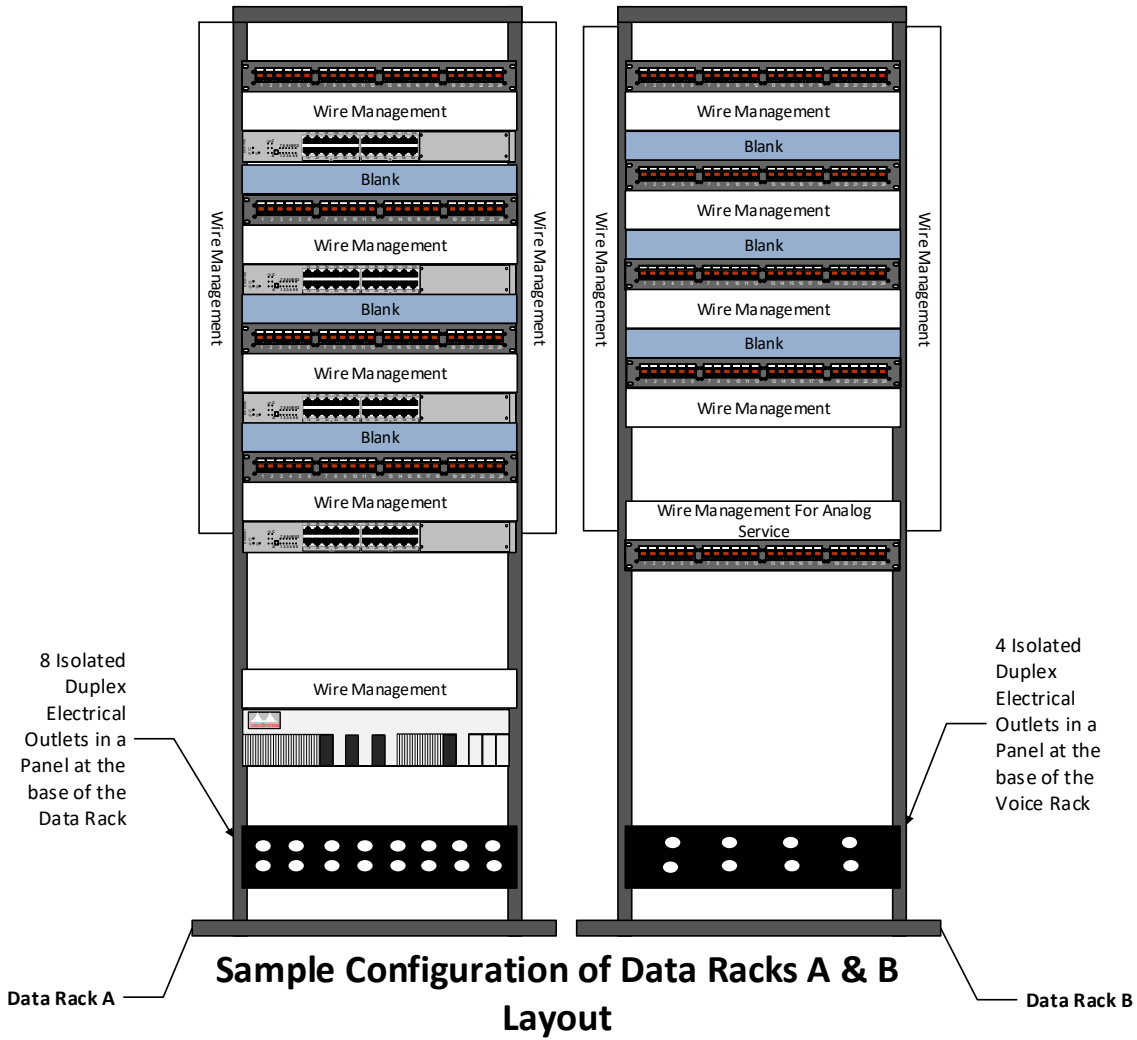

Voice/Data Rack Layout - Large Office

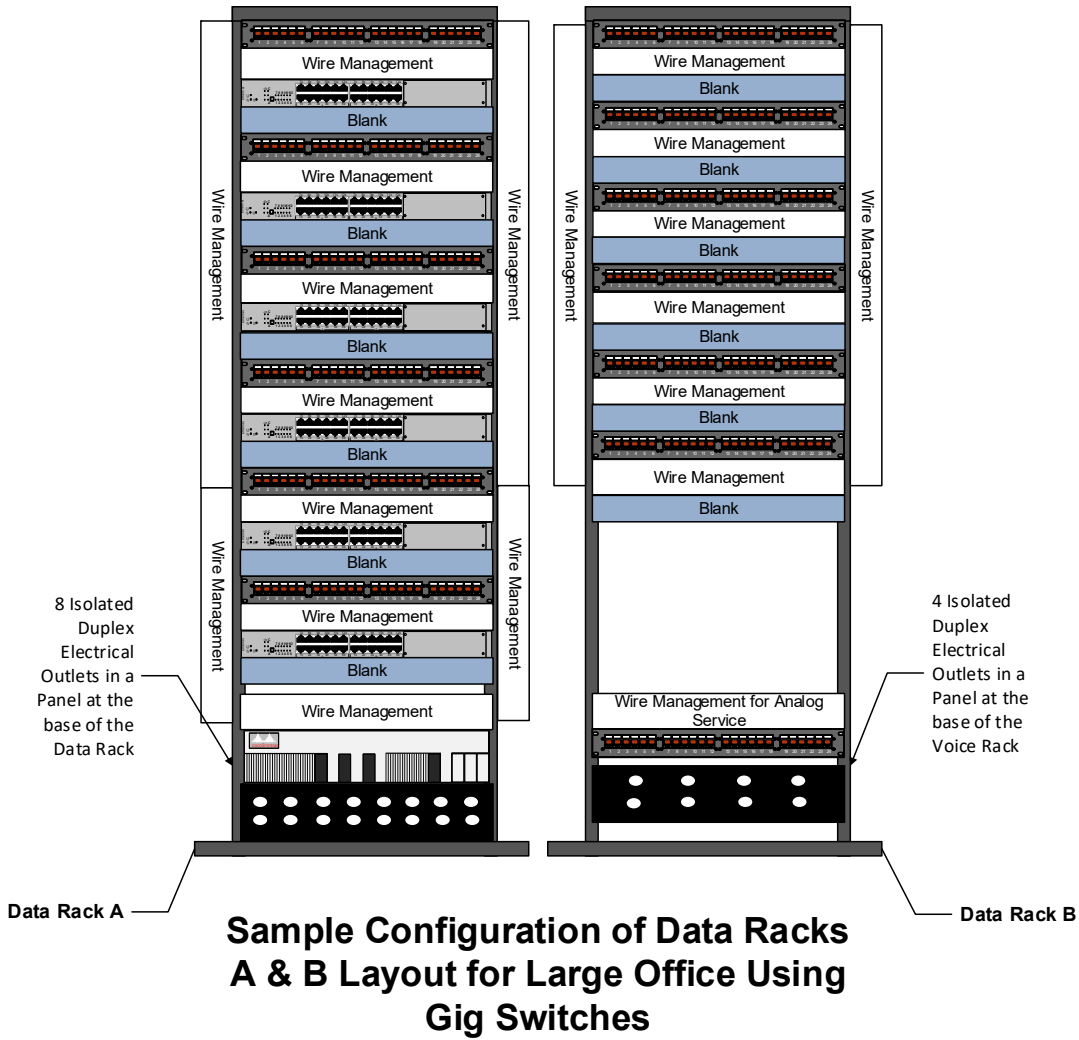
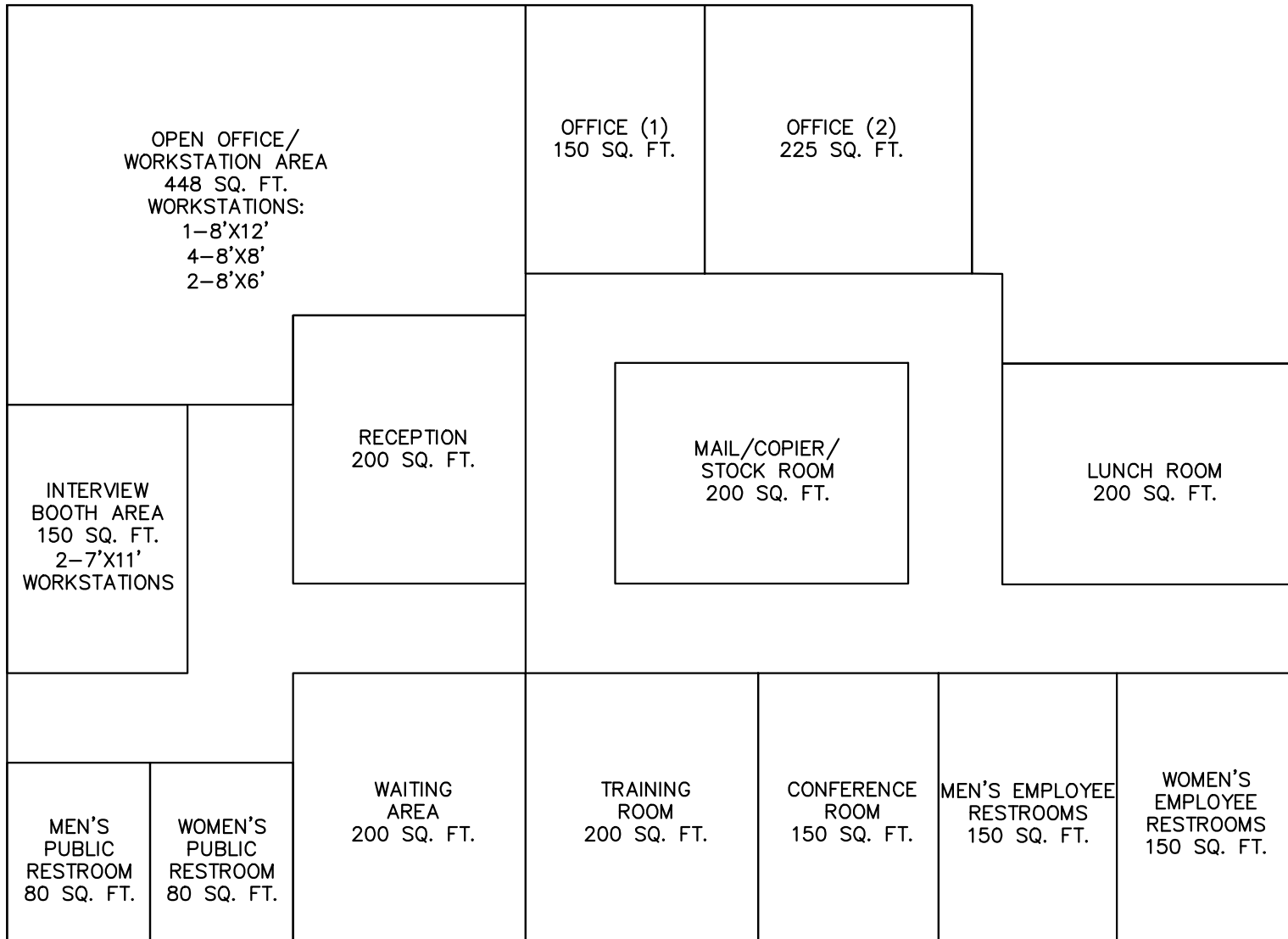

Exhibit 4-Test Fit Out Floor Plan



SULLIVAN CAO SCHEMATIC
 APPROVED SF RANGE:
 3,322-3,821 SF

APPENDIX E

GEOGRAPHIC BOUNDARIES

Sullivan CAO Boundaries Overview

